

**FLEXFORM**



**LONG ISLAND 05** *DESIGN CENTER 2005*  
SECTIONAL SOFAS

---

**FLEXFORM** Spa

Via Einaudi 23/25 20821 Meda (MB) Italy | Tel. +39 0362 3991 | [info@flexform.it](mailto:info@flexform.it) | [www.flexform.it](http://www.flexform.it)

---

## LONG ISLAND 05 | *DESIGN CENTER* | 2005

**Structure** in solid wood with polyurethane foam padding, covered with a protective laminated fabric

**Seat cushions** in sterilized goose down (Assopiuma certified, gold label) with insert in crushproof material or in polyurethane foam and dacron

**Backrest cushions** in sterilized goose down (Assopiuma certified, gold label) and fiber

**Optional cushions** in sterilized goose down (Assopiuma certified, gold label). Optional cushions are upon request, with upcharge

**Feet** hidden feet

**Upholstery** removable fabric or not removable leather covers

### FIT-IN BACKREST / SERVICE TABLES

**Cushion** in sterilized goose down (Assopiuma certified, gold label) with polyurethane foam support bolster. The optional cushion with bolster is upon request, with upcharge

**Frame** in metal covered with hide leather: russian red 5008, olive 5006, black 5005, dark brown 5004, dark brown extra 5013, grey 5003, sand 5001, tobacco 5015. Also available in black suede 6005, dark brown suede 6004, olive suede 6003, sand suede 6001

COD. 012V12

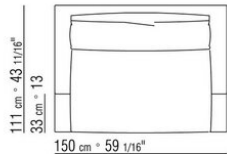
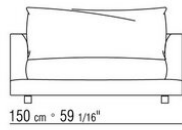
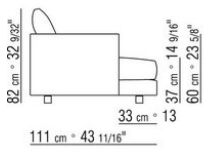

COD. 012V18

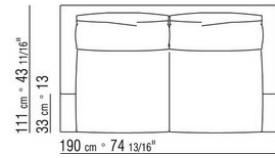
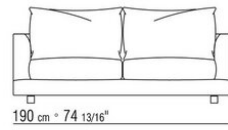
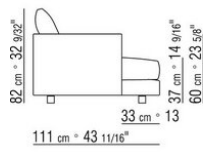

COD. 012V13

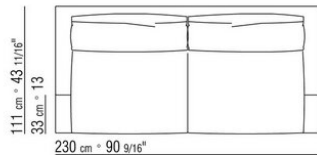
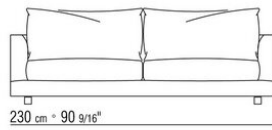
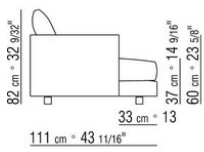

COD. 012V14

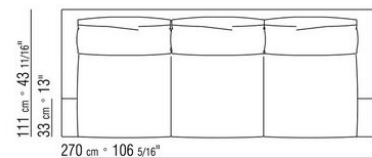
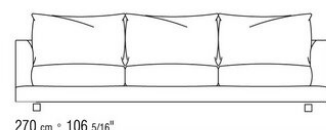
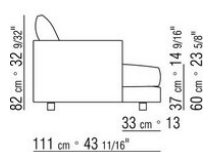

COD. 012V51

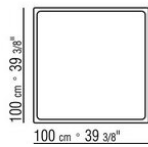
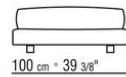
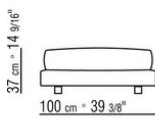

COD. 012V50

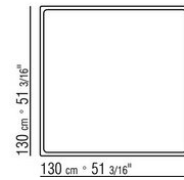
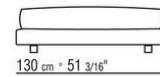
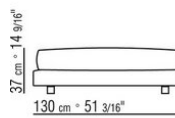

COD. 012V53

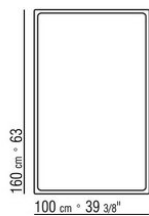
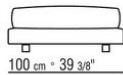
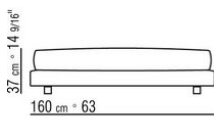

COD. 012V61

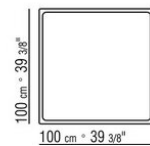
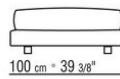
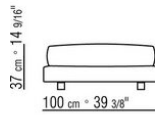

# TECHNICAL DRAWINGS | LONG ISLAND 05

COD. 012V60

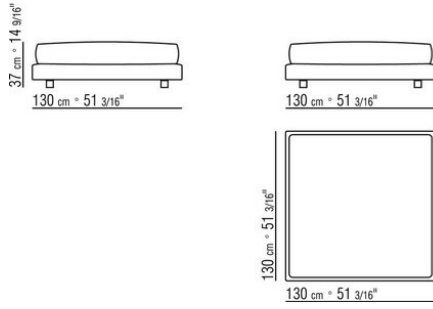

COD. 012V63

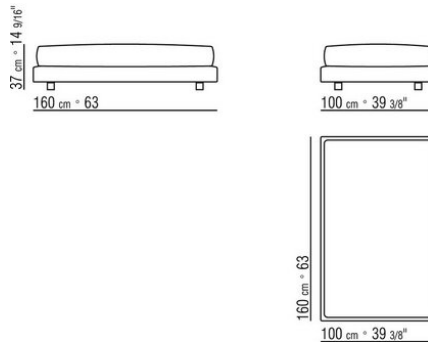

COD. 012V23

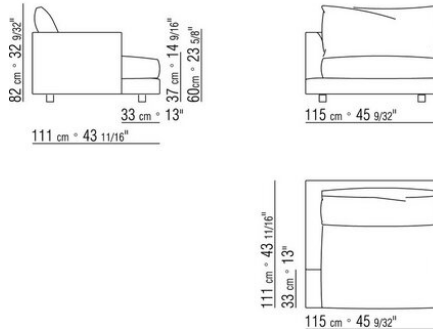

COD. 012V25

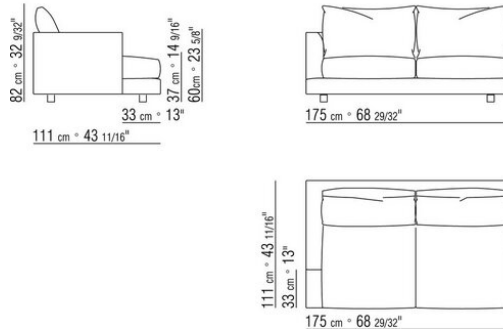

COD. 012V27

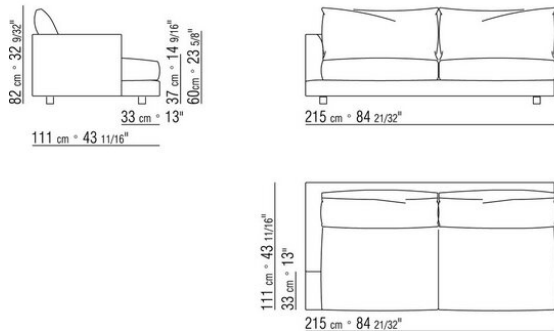

COD. 012V28

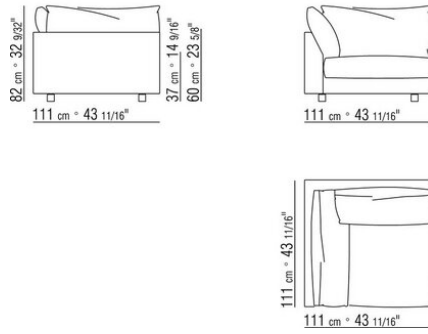

COD. 012V21

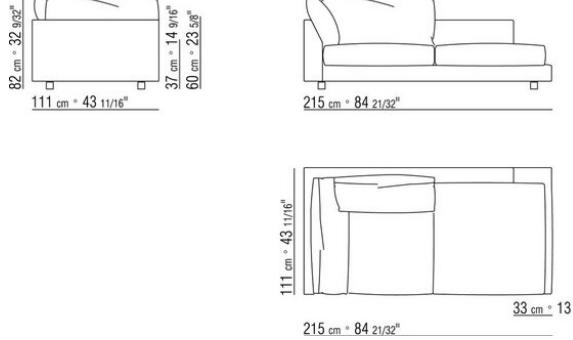

COD. 012V33

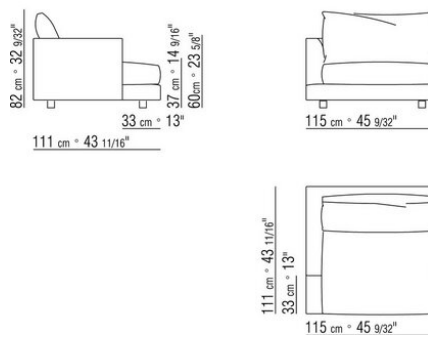

COD. 012V35

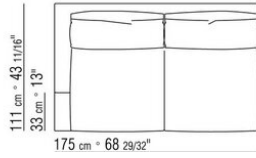
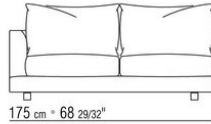
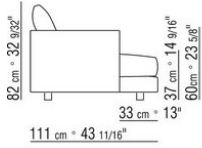

COD. 012V37

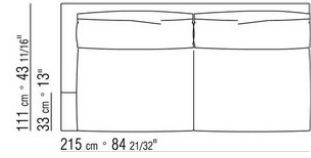
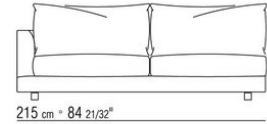
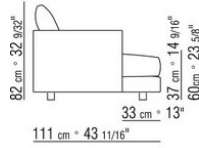

COD. 012V38

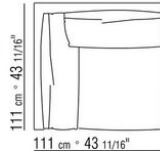
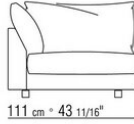
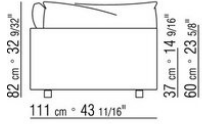

COD. 012V31

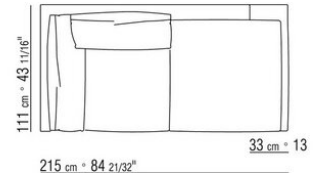
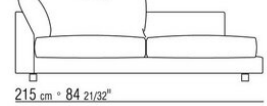
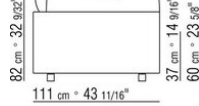

COD. 012V96

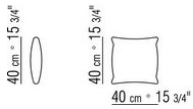

COD. 012V97

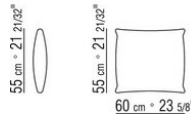

COD. 012V99

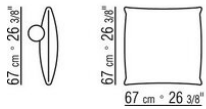

COD. 012V80

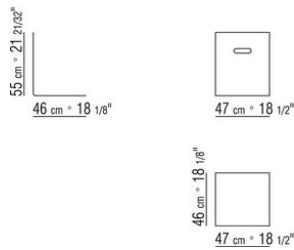

COD. 012V71

COD. 012V70

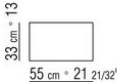
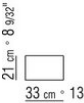
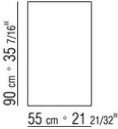

## COMPOSITIONS | LONG ISLAND 05

---

012VXA

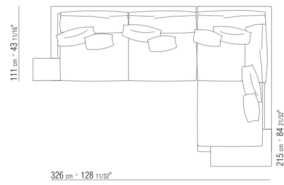

- N.1 COD.012V70 - SIDETABLE CM.33 x55
- N.1 COD.012V21 - LONG CORNER L CM.111 x215
- N.1 COD.012V27 - END UNIT L CM.215 x111
- N.1 COD.012V71 - SIDETABLE CM.90 x55
- N.4 COD.012V96 - CUSHION CM.40 x40
- N.4 COD.012V97 - CUSHION CM.60 x55

012VXB

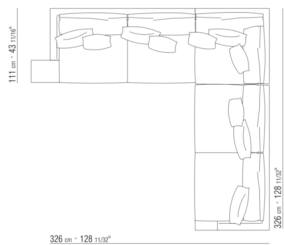

- N.1 COD.012V70 - SIDETABLE CM.33 x55
- N.1 COD.012V28 - CORNER CM.111 x111
- N.1 COD.012V27 - END UNIT L CM.215 x111
- N.1 COD.012V26 - END UNIT R CM.215 x111
- N.5 COD.012V96 - CUSHION CM.40 x40
- N.5 COD.012V97 - CUSHION CM.60 x55