



Tristan Auer disegna per Poltrona Frau una collezione di pouf dall'eleganza nomade, versatile e trasversale: le sedute Grant vivono con la stessa disinvoltura negli spazi pubblici o residenziali, singolarmente o accostate in combinazioni personalizzabili.

CARATTERISTICHE TECNICHE

Modelli.

- Pouf 60×40 De Luxe
- Pouf 140×80
 - tipo A De Luxe
 - tipo B De Luxe
 - tipo B De Luxe con braccioli
 - tipo B
 - tipo B con braccioli
- Pouf 110×110
 - tipo A De Luxe
 - tipo B De Luxe
 - tipo B

CARATTERISTICHE COMUNI A TUTTI I MODELLI

Struttura. In multistrato di betulla.

Imbottitura. Seduta e fianchi sono imbottiti in poliuretano espanso.

Zoccolo inferiore. In MDF verniciato nero testurizzato con puntali in plastica nera a protezione del pavimento.

Dettagli estetici (eccetto Pouf 60×40). Due cinte decorative avvolgono verticalmente la struttura del pouf. Alla base delle cinte sono poste delle fibbie in acciaio con trattamento galvanico ruthenium.

MODELLI DE LUXE

I modelli sono caratterizzati da una particolare lavorazione a intreccio, realizzata con fasce in Pelle Frau® larghe 6 cm a 45°, che decora la struttura perimetrale dei pouf.

Rivestimento. Nei modelli De Luxe il rivestimento in pelle è disponibile solo nelle seguenti pelli/colori:

- Color System Frau® (SC)
 - SC 10 Antracite
 - SC 26 Topo
 - SC 28 Seppia
 - SC 68 Sahara
 - SC 80 Bruno Havana
- Soul
 - Joe
 - Diana
 - Amy
 - Dusty
 - Stevie

Tristan Auer has designed a collection of poufs for Poltrona Frau which stand out for their nomadic, versatile and flexible elegance: the Grant seats are equally at home in public and residential settings, on their own or in bespoke combinations.

TECHNICAL FEATURES

Items.

- 60×40 De Luxe Ottoman
- 140×80 Ottoman
 - type A De Luxe
 - type B De Luxe
 - type B De Luxe with armrests
 - type B
 - type B with armrests
- 110×110 Ottoman
 - type A De Luxe
 - type B De Luxe
 - type B

FEATURES COMMON TO ALL ITEMS

Structure. Made of birch plywood.

Padding. The seat and sides are padded with polyurethane foam.

Lower base. In MDF in texturised black paint with black plastic caps to protect the floor.

Aesthetic details (except for 60×40 Ottoman). Two decorative belts are wrapped vertically around the frame of the ottoman. At the base of the belts there are steel buckles with ruthenium galvanic treatment.

DE LUXE ITEMS

The items are distinctive for their original latticework - consisting of 6 cm-wide strips of handwoven Pelle Frau® leather at a 45° angle - which decorates the perimetral upholstery of the ottomans.

Upholstery. In the De Luxe items, the leather upholstery is only available in the following leathers/colours:

- Color System Frau® (SC)
 - SC 10 Antracite
 - SC 26 Topo
 - SC 28 Seppia
 - SC 68 Sahara
 - SC 80 Bruno Havana
- Soul
 - Joe
 - Diana
 - Amy
 - Dusty
 - Stevie

POUF TIPO "A"**Configurazioni disponibili.**

- Pouf 140×80
- Pouf 110×110

Sono disponibili solo nella versione De Luxe e sono caratterizzati da una base alta, sempre rivestita in pelle con lavorazione ad intreccio, e da un cuscino seduta basso rivestibile in pelle o in tessuto.

Rivestimento. In Pelle Frau® o nell'abbinamento della pelle con il tessuto. La base è sempre rivestita in pelle con particolare lavorazione a intreccio, mentre il cuscino seduta può essere in pelle liscia abbinata o in tessuto.

- Color System Frau® (SC)
- Color System Frau® (SC) / Fabric A
- Color System Frau® (SC) / Fabric B
- Color System Frau® (SC) / COM
- Soul
- Soul / Fabric A
- Soul / Fabric B
- Soul / COM

N.B. il rivestimento in pelle (sia le parti con lavorazione a intreccio che in pelle liscia) è disponibile solo nei colori previsti per i modelli De Luxe (vedi sopra).

Sfoderabilità. Non prevista.

Cinte decorative. Sono realizzate in Pelle Frau® in abbinamento al rivestimento della base e scompaiono sotto il cuscino seduta.

POUF TIPO "B"**Configurazioni disponibili.**

- Pouf 140×80
- Pouf 140×80 con braccioli
- Pouf 110×110

Sono caratterizzati da una base bassa, sempre rivestita in pelle e da un cuscino seduta alto in tessuto o, nella versione De Luxe, in pelle con rivestimento perimetrale realizzato con caratteristica lavorazione a intreccio e superficie della seduta sempre in pelle liscia abbinata.

Rivestimento.

- **Pelle Frau®.** Il rivestimento in tutta pelle (sia le parti con lavorazione a intreccio che in pelle liscia) è disponibile solo nei colori previsti per i modelli De Luxe (vedi sopra).
- **Tessuto / Pelle Frau®:** in questo caso il rivestimento prevede l'abbinamento del tessuto alla pelle, liberamente scelta senza vincoli di tipo e colore. La base è rivestita in pelle e il cuscino seduta e le cinte decorative in tessuto.
- Fabric A / Color System Frau® (SC)
- Fabric A / Nest
- Fabric A / Soul
- Fabric A / Century
- Fabric B / Color System Frau® (SC)
- Fabric B / Nest
- Fabric B / Soul
- Fabric B / Century
- C.O.M. / Color System Frau® (SC)
- C.O.M. / Nest
- C.O.M. / Soul
- C.O.M. / Century

Sfoderabilità. Non prevista.

Cinte decorative (pouf senza braccioli). Sono realizzate in Pelle Frau® o in tessuto in abbinamento al rivestimento del cuscino seduta.

Braccioli. I pouf 140×80 di tipo B sono disponibili
- con kit braccioli composto da due coppie di cuscini rettangolari agganciati

TYPE "A" OTTOMAN**Available configurations.**

- 140×80 Ottoman
- 110×110 Ottoman

Available only in the De Luxe version, they have a high base, upholstered in leather with latticework, and a low seat cushion that can be covered in leather or fabric.

Upholstery. In Pelle Frau® leather or a combination of leather and fabric. The base is always covered in leather with distinctive latticework, while the seat cushion can be in smooth matching leather or fabric.

- Color System Frau® (SC)
- Color System Frau® (SC) / Fabric A
- Color System Frau® (SC) / Fabric B
- Color System Frau® (SC) / COM
- Soul
- Soul / Fabric A
- Soul / Fabric B
- Soul / COM

N.B. the leather upholstery (both the smooth parts and the parts with lattice work) is only available in the colours of the De Luxe items (see above).

Removable cover. Not possible.

Decorative belts. Made from Pelle Frau® leather matching the upholstery of the base, they disappear under the seat cushion.

TYPE "B" OTTOMAN**Available configurations.**

- 140×80 Ottoman
- 140×80 Ottoman with armrests
- 110×110 Ottoman

They have a low base upholstered in leather and a high seat cushion in fabric or, in the De Luxe version, in leather with external cover with distinctive latticework, and a seat surface always in smooth matching leather.

Upholstery.

- Pelle Frau® leather. The full-leather upholstery (both the smooth parts and the parts with lattice work) is only available in the colours of the De Luxe items (see above).
- Fabric / Pelle Frau® leather: in this case the upholstery is a combination of fabric and leather, freely chosen without any constraints in terms of type or colour. The base is upholstered in leather while the seat cushion and the decorative belts in fabric.
- Fabric A / Color System Frau® (SC)
- Fabric A / Nest
- Fabric A / Soul
- Fabric A / Century
- Fabric B / Color System Frau® (SC)
- Fabric B / Nest
- Fabric B / Soul
- Fabric B / Century
- C.O.M. / Color System Frau® (SC)
- C.O.M. / Nest
- C.O.M. / Soul
- C.O.M. / Century

Removable cover. Not possible.

Decorative belts (ottoman without armrests). Made from Pelle Frau® leather or fabric matching the upholstery of the seat cushion.

Armrests. Type B 140×80 ottomans are available
- with an armrest kit, which consists of two pairs of rectangular cushions

alle cinte decorative. (imbottiti in poliuretano espanso)
- senza braccioli

Cinte decorative e braccioli. In questo caso le cinte avvolgono la seduta e sono dotate di bottoni automatici per bloccare i cuscini bracciolo. Il rivestimento di cinte e cuscini è, a scelta, in pelle o in tessuto in abbinamento alla base o al cuscino seduta.

- Color System Frau® (SC)
- Nest
- Soul
- Century
- Fabric A*
- Fabric B*
- C.O.M.

* Sono disponibili anche i tessuti Kvadrat

N.B. In caso di rivestimento in sola Pelle Frau (modelli De Luxe) le cinte e i cuscini saranno rivestibili o in tessuto (scelta libera) o nella stessa pelle specificata per il pouf.

Dettagli estetici. Un filetto in pelle delimita la seduta ed è sempre abbinato al rivestimento della base.

attached to the decorative belts (padded in polyurethane foam)
- without armrests

Decorative belts and armrests. In this case the belts wrap around the seat and come with snap buttons to hold the armrest cushions in place. The belts and cushions can be upholstered in leather or fabric matching the base or seat cushion.

- Color System Frau® (SC)
- Nest
- Soul
- Century
- Fabric A*
- Fabric B*
- C.O.M.

* Kvadrat fabrics also available

N.B. Where the upholstery is only in Pelle Frau® leather (De Luxe items) the belts and cushions can be upholstered in fabric (free choice) or in the same leather specified for the ottoman.

Aesthetic details. A leather trim matching the cover of the base frames the seat.

TIPOLOGIE DISPONIBILI / AVAILABLE TYPOLOGIES

TIPO A / TYPE A

SOLO VERSIONE "DE LUXE" / ONLY IN THE "DE LUXE" VERSION

base alta in pelle intrecciata
woven leather high base

+

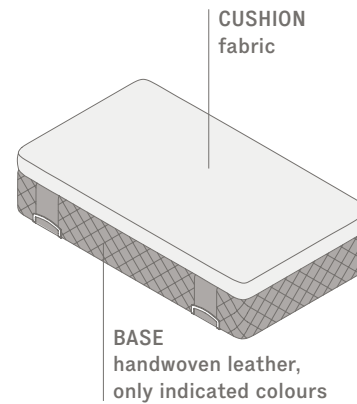
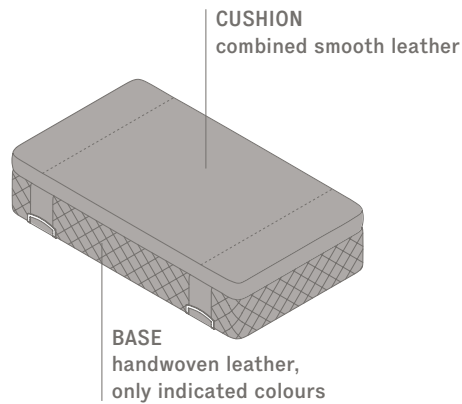
cuscino seduta basso in pelle o in tessuto
low seat cushion in leather or fabric**TIPO B / TYPE B**base bassa in pelle
low base in leather

+



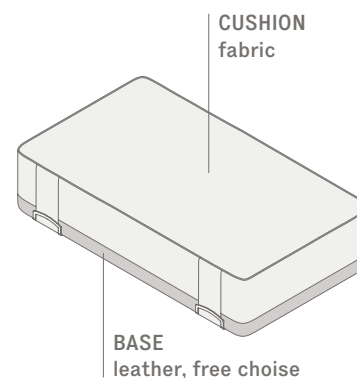
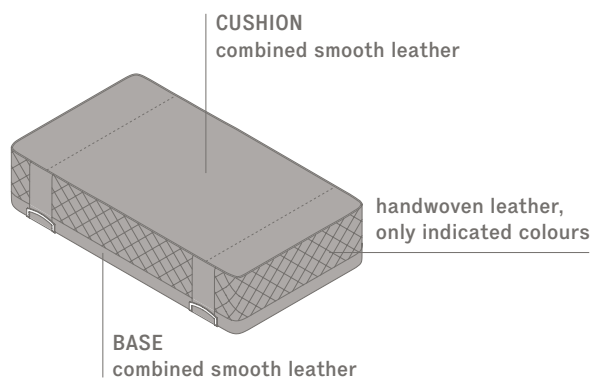

cuscino seduta alto in pelle (con rivestimento perimetrale in pelle intrecciata) o in tessuto
high seat cushion in leather (with handwoven leather perimetral upholstery) or in fabric

DE LUXE VERSION

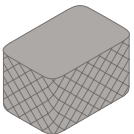
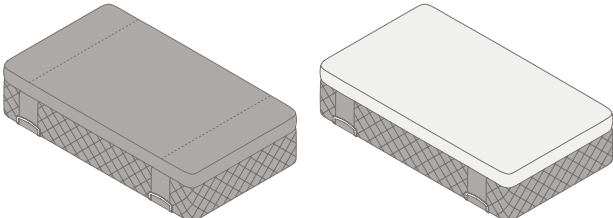
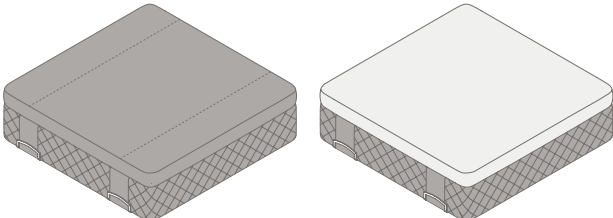
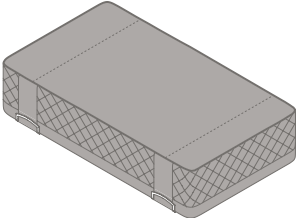
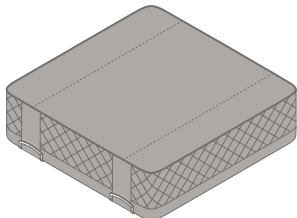
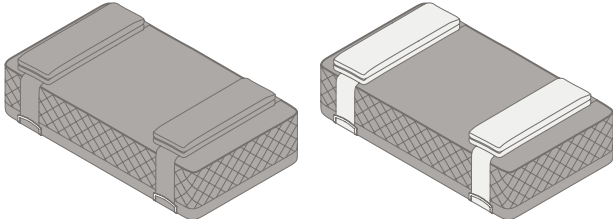
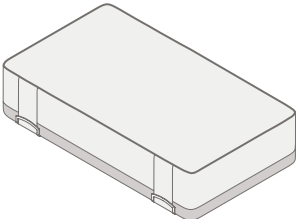
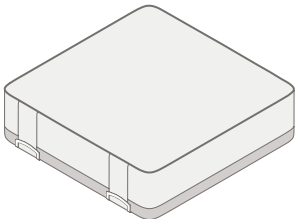
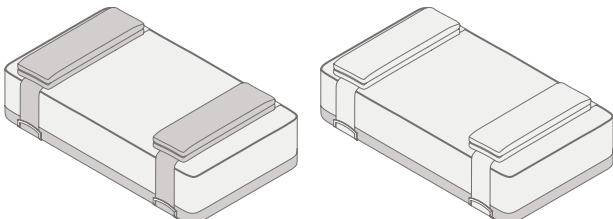

N.B.: i disegni si riferiscono alla misura 140×80 ma le stesse regole sono applicabili anche ai pouf 110×110
 Please note: drawings refer to the 140×80 size but the same rules are valid for 110×110 ottomans

REGOLE APPLICAZIONE RIVESTIMENTI / UPHOLSTERY APPLICATION RULES

OTTOMAN 60X40	RECTANGULAR OTTOMAN 140X80	SQUARE OTTOMAN 110X110
<p>5648511 OTTOMAN 60X40 DE LUXE</p> 	<p>5648531 OTTOMAN 140X80 DE LUXE TYPE A</p> 	<p>5648541 OTTOMAN 110X110 DE LUXE TYPE A</p> 
	<p>5648532 OTTOMAN 140X80 DE LUXE TYPE B</p> 	<p>5648542 OTTOMAN 110X110 DE LUXE TYPE B</p> 
	<p>5648533 OTTOMAN 140X80 DE LUXE TYPE B WITH ARMS</p> 	
	<p>5648534 OTTOMAN 140X80 TYPE B</p> 	<p>5648543 OTTOMAN 110X110 TYPE B</p> 
	<p>5648535 OTTOMAN 140X80 TYPE B WITH ARMS</p> 	<p>  Fabric (A, B, C.O.M.)  Pelle Frau® SC / Soul (solo colori indicati / <i>only indicated colours</i>)  Pelle Frau® (libera scelta / <i>free choice</i>) </p>

5648511

42 / 16¹/₂"45 / 17³/₄"65 / 25¹/₂"

5648531



Pelle Frau® upholstery



Fabric upholstery

38 / 15"

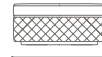
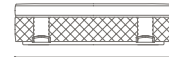
85 / 33¹/₂"

145 / 57"

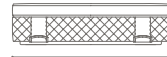

145 / 57"

5648532

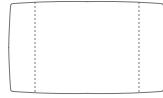

38 / 15"

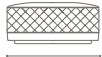
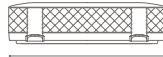
85 / 33¹/₂"

145 / 57"

5648533

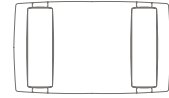

51 / 20"

85 / 33¹/₂"

145 / 57"

5648534

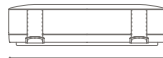

38 / 15"

85 / 33¹/₂"

145 / 57"

5648535

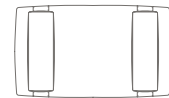

51 / 20"

85 / 33¹/₂"

145 / 57"

5648541

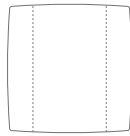

Pelle Frau® upholstery

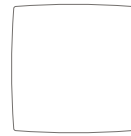

Fabric upholstery

38 / 15"

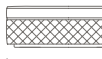
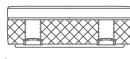
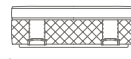
115 / 45³/₄"115 / 45³/₄"115 / 45³/₄"

5648542

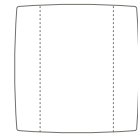

38 / 15"

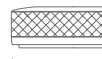
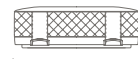
115 / 45³/₄"115 / 45³/₄"

5648543

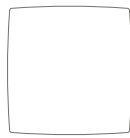

38 / 15"

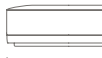
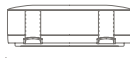
115 / 45³/₄"115 / 45³/₄"

ESEMPIO DI COMPOSIZIONE 1 / LAYOUT EXAMPLE NO. 1

- 5648541 Ottoman 110×110 De Luxe Type A
- 5648532 Ottoman 140×80 De Luxe Type B
- 5648511 Ottoman 60×40 De Luxe
- 5648535 Ottoman 140×80 Type B with arms

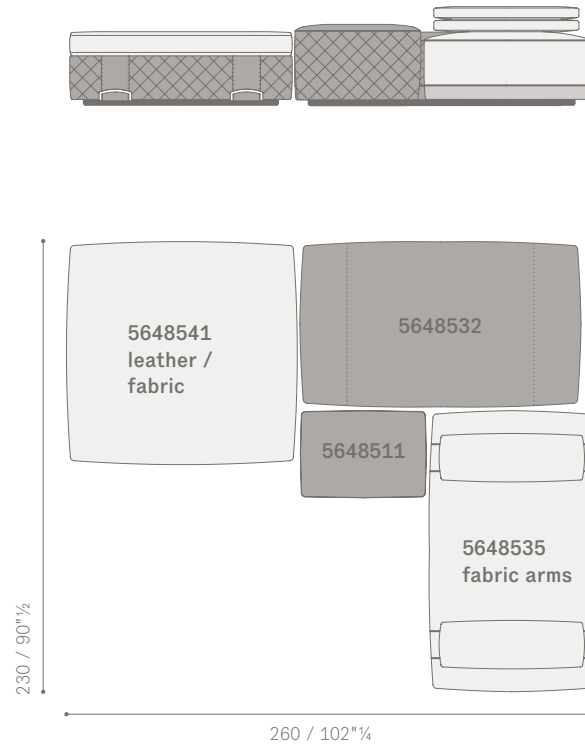

ESEMPIO DI COMPOSIZIONE 2 / LAYOUT EXAMPLE NO. 2

- 5648531 Ottoman 140×80 De Luxe Type A
- 5648533 Ottoman 140×80 De Luxe Type B with arms
- 5648543 Ottoman 110×110 Type B
- 5648541 Ottoman 110×110 De Luxe Type A
- 5648511 Ottoman 60×40 De Luxe

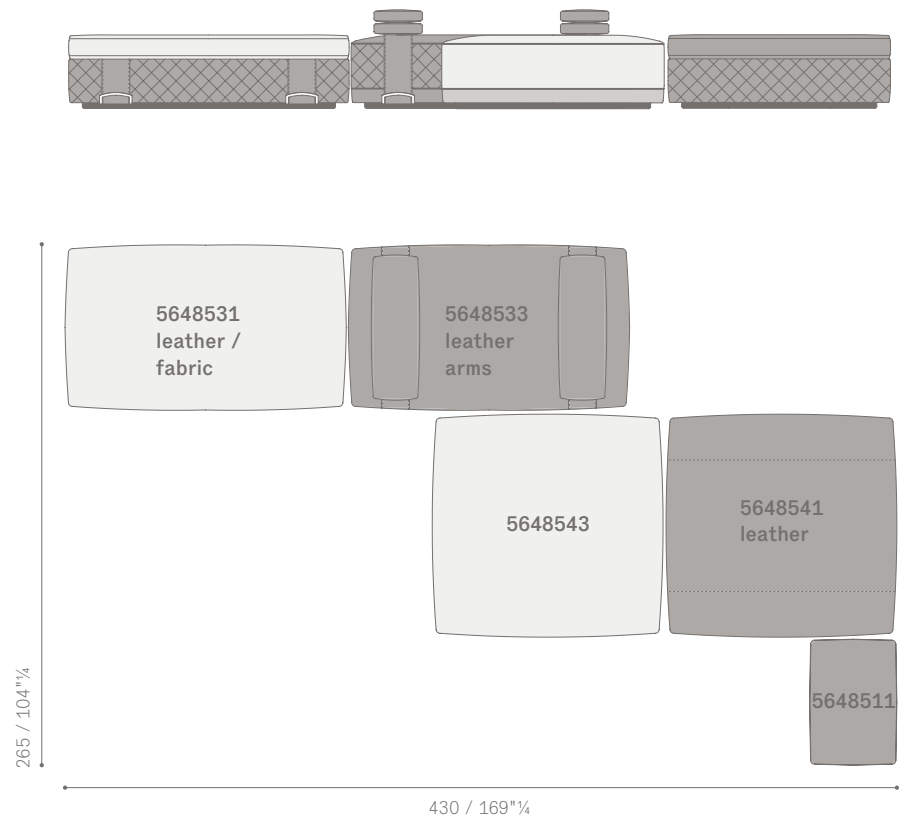

ESEMPIO DI COMPOSIZIONE 3 / LAYOUT EXAMPLE NO. 3

- 5648511 Ottoman 60×40 De Luxe
- 5648532 Ottoman 140×80 De Luxe Type B
- 5648543 Ottoman 110×110 Type B

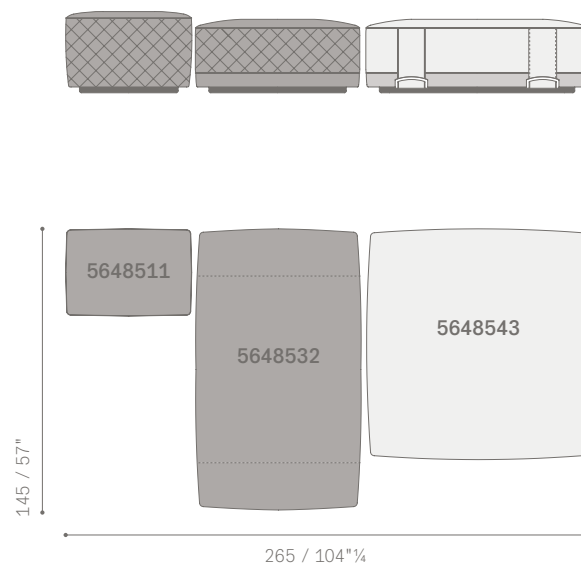

ESEMPIO DI COMPOSIZIONE 4 / LAYOUT EXAMPLE NO. 4

- 5648531 Ottoman 140×80 De Luxe Type A
- 5648535 Ottoman 140×80 Type B with arms
- 5648511 Ottoman 60×40 De Luxe
- 5648511 Ottoman 60×40 De Luxe

