

FLEXFORM



FEEL GOOD ANTONIO CITTERIO 2009
SECTIONAL SOFAS

FLEXFORM Spa

Via Einaudi 23/25 20821 Meda (MB) Italy | Tel. +39 0362 3991 | info@flexform.it | www.flexform.it

FEEL GOOD | ANTONIO CITTERIO | 2009

SOFAS / SECTIONAL SOFAS OTTOMANS / DORMEUSE

Frame seat frame in metal covered in hide leather: russian red 5008, olive 5006, black 5005, dark brown 5004, dark brown extra 5013, grey 5003, sand 5001, tobacco 5015. Also available in black suede 6005, dark brown suede 6004, olive suede 6003, sand suede 6001. With polyurethane underseat

Structure in solid wood with polyurethane foam and molded polyurethane foam padding, covered with a protective laminated fabric

Seat cushions in polyurethane foam and dacron

Backrest cushions in sterilized goose down (Assopiuma certified, gold label)

Optional cushions in sterilized goose down (Assopiuma certified, gold label). Optional cushions are upon request, with upcharge

Feet in satined, chrome, burnished, black chrome, glossy anthracite metal, or covered with hide leather: russian red 5008, olive 5006, black 5005, dark brown 5004, dark brown extra 5013, grey 5003, sand 5001, tobacco 5015. Also available in black suede 6005, dark brown suede 6004, olive suede 6003, sand suede 6001. Rests on pads made of thermoplastic material

Upholstery removable fabric or not removable leather

COD. 014W06

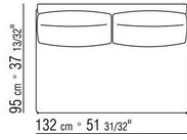
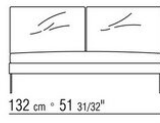

COD. 014W05

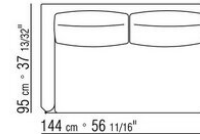
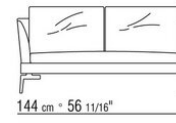
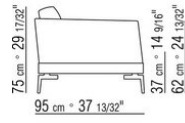

COD. 014W15

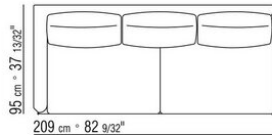
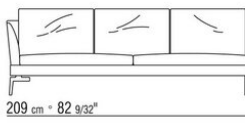
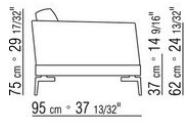

COD. 014W09

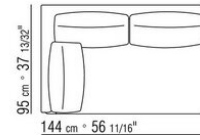
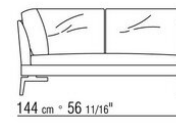
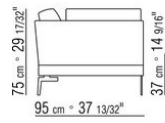

COD. 014W17

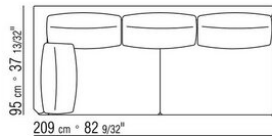
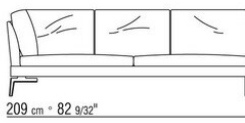
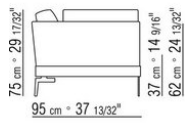

COD. 014W11

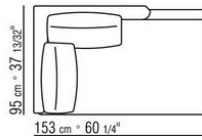
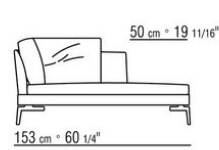
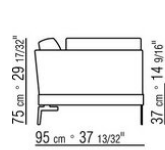

COD. 014W19

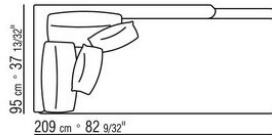
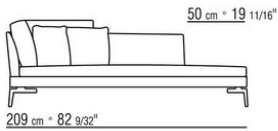
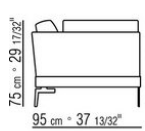

COD. 014W33

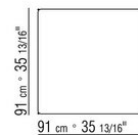
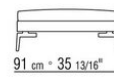
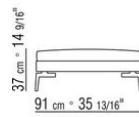

COD. 014W34

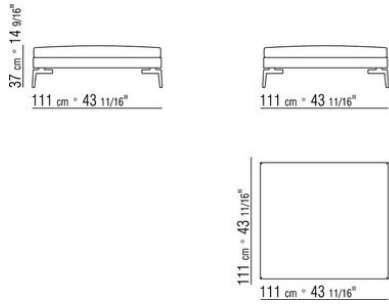

COD. 014W98

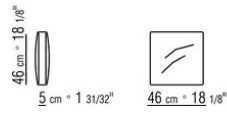

COD. 014W99

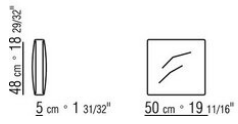

COD. 014W97

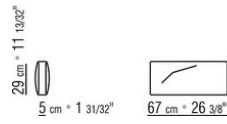

COD. 014W96



COMPOSITIONS | FEEL GOOD

014WXA

- N.1 COD.014W15 - END UNIT L CM.209 x95
- N.6 COD.014W98 - CUSHION CM.46 x46
- N.1 COD.014W19 - LONG CORNER L CM.95 x209

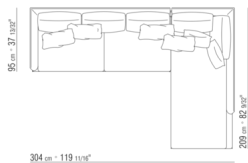

014WXB

- N.1 COD.014W05 - END UNIT L CM.144 x95
- N.7 COD.014W98 - CUSHION CM.46 x46
- N.1 COD.014W04 - END UNIT R CM.144 x95
- N.1 COD.014W08 - CORNER R CM.144 x95

