

Let it Be – Ludovica + Roberto Palomba – 2017



Sistema modulare e aperto alle configurazioni più confortevoli, Let it Be invita a una gestualità rilassata. È l'accogliente rifugio nel quale finalmente lasciare fuori casa ogni pensiero e ritrovare i propri tempi e ritmi. Un'autentica isola di benessere attrezzata di tutto ciò che serve.

CARATTERISTICHE TECNICHE

Base. Telaio in alluminio da trafilatura.

Struttura schienali e braccioli. In massello di pioppo, multistrato di betulla e tamponamento con pannelli in faesite.

Imbottitura schienale e braccioli. In poliuretano espanso e ovatta poliestere.

Imbottitura cuscino seduta. In piuma d'oca e ovatta poliestere con inserto stabilizzante in poliuretano espanso.

Molleggio. Seduta: con cinghie elastiche intrecciate. Schienale e braccioli: con cinghie elastiche.

Altri elementi strutturali (traversa centrale, piastre angolari, piastre fissaggio schienale e piastre sostegno accessori). In lamiera d'acciaio verniciato nero.

Rivestimento. Interamente in Pelle Frau® o nelle opzioni che abbinano più materiali. Il primo rivestimento viene applicato alla base mentre il secondo alle imbottiture previste per seduta, schienale e braccioli.

- | | |
|---------------------------------|-------------------------------------|
| - Color System Frau® | - Saddle / Color System Frau® |
| - Color System Frau® / Fabric A | - Saddle / Nest |
| - Color System Frau® / Fabric B | - Saddle / Soul |
| - Color System Frau® / C.O.M. | - Saddle / Fabric A |
| - Nest | - Saddle / Fabric B |
| - Nest / Fabric A | - Saddle / C.O.M. |
| - Nest / Fabric B | - Saddle Extra / Color System Frau® |
| - Nest / C.O.M. | - Saddle Extra / Nest |
| - Soul | - Saddle Extra / Soul |
| - Soul / Fabric A | - Saddle Extra / Fabric A |
| - Soul / Fabric B | - Saddle Extra / Fabric B |
| - Soul / C.O.M. | - Saddle Extra / C.O.M. |

Per verificare i tessuti disponibili si prega di consultare la tabella dedicata "Schema abbinamento prodotti-tessuti".

Si consiglia di arricchire la composizione scelta con i cuscini schienale opzionali, prevedendo un cuscino per ogni schienale.

Sfoderabilità. Prevista solo per le parti rivestite in tessuto.

Dettagli estetici. I rivestimenti in pelle e tessuto hanno filo tono su tono. Il rivestimento in cuoio prevede cuciture a contrasto.

Piedi. In alluminio ottenuto da stampo con finitura ruthenium e puntali in nylon nero a protezione del pavimento. Disponibili in due altezze:

- h 19 (standard)
- h 22 (opzionale a richiesta)

A modular system open to the most comfortable of configurations, Let it Be is an invitation to relax. It is a welcoming refuge where you can finally leave your worries behind you and rediscover your own time and rhythms. An authentic island of wellbeing equipped with everything you need.

TECHNICAL FEATURES

Base. Frame made of aluminium die.

Backrest and armrests structure. Made of solid poplar wood, birch plywood and hardboard panels.

Backrest and armrests padding. In polyurethane foam and polyester wadding.

Cushions padding. Padded with feathers with stabilising insert in polyurethane foam and polyester wadding.

Seat suspension. Seating: with woven elastic belts. Backseat and armrest: elastic belts

Other structural elements (midbeam with foot, corner plates and other metal accessories). Made from black coated steel sheet.

Upholstery. Fully upholstered in Pelle Frau® leather or in a combination of two materials. The first upholstery mentioned below is used for the base, while the second one is used for the seating, backrest and armrests.

- | | |
|---------------------------------|-------------------------------------|
| - Color System Frau® | - Saddle / Color System Frau® |
| - Color System Frau® / Fabric A | - Saddle / Nest |
| - Color System Frau® / Fabric B | - Saddle / Soul |
| - Color System Frau® / C.O.M. | - Saddle / Fabric A |
| - Nest | - Saddle / Fabric B |
| - Nest / Fabric A | - Saddle / C.O.M. |
| - Nest / Fabric B | - Saddle Extra / Color System Frau® |
| - Nest / C.O.M. | - Saddle Extra / Nest |
| - Soul | - Saddle Extra / Soul |
| - Soul / Fabric A | - Saddle Extra / Fabric A |
| - Soul / Fabric B | - Saddle Extra / Fabric B |
| - Soul / C.O.M. | - Saddle Extra / C.O.M. |

To verify the available fabrics please consult the dedicated table "Combination models-fabrics pattern".

It is advisable to enrich the chosen composition with the optional back cushions, providing one cushion per each backseat.

Removability. Only for the parts upholstered in fabric.

Aesthetic details. The leather and fabric versions have a tone on tone stitching. The saddle version has a contrast stitching.

Feet. Made of moulded aluminium with a ruthenium stitching and plastic black caps. Available in two different heights:

- h 19 (standard)
- h 22 (optional, on request)

È possibile realizzare configurazioni simmetriche e asimmetriche utilizzando 2 braccioli di diverse altezze, un mobile terminale, un mobile schienale e un appoggio per cuscino cilindrico.

MOBILE TERMINALE E MOBILE SCHIENALE

Mobile terminale e Mobile schienale. Disponibili in sostituzione ai braccioli dx o sx (mobile terminale) o agli schienali (mobile schienale) nelle versioni asimmetriche, componibili o angolari.

Struttura mobili (solo per i moduli che li prevedono). In alluminio curvato e divisorio interno in multistrato di betulla.

Rivestimento in:

- Cuoio Saddle
- Cuoio Saddle Extra

Con cuciture a contrasto.

ACCESSORI E COMPLEMENTI

CUSCINI

Cuscini schienale 65×65 opzionali suggeriti. Non inclusi nel prezzo. In piuma d'oca a camere orizzontali separate a differenziare le aree di comfort. Si consiglia di prevedere un cuscino per ogni schienale.

Cuscino cilindrico. In piuma d'oca. Disponibile in due versioni:

- 65 cm
- 75 cm

Rivestimento cuscini. In Pelle Frau® o in tessuto:

- | | |
|----------------------|------------|
| - Color System Frau® | - Fabric A |
| - Heritage | - Fabric B |
| - Nest | - C.O.M. |
| - Soul | |

C.O.M. (Fabric/Mt. plain - Fabric/Mt. repeat)

Cuscino 65X65: 1,5-1,7

Cuscino cilindrico 65 cm: 0,8-0,9

Cuscino cilindrico 74 cm: 0,8-0,9

SUPPORTO CUSCINI

Supporto poggiatesta per cuscino schienale 65×65. Realizzato con tondino metallico e lamiera curvata. Da posizionare tra il cuscino 65×65 e lo schienale, garantisce il giusto supporto alla testa.

Rivestimento. In Pelle Frau®

- Color System Frau®
- Nest
- Soul

Supporto per cuscino cilindrico.

- 66 cm (consigliato per il cuscino cilindrico da 75 cm e previsto per montaggio in caso di modulo con panca)

- 33 cm (consigliato per il cuscino cilindrico da 65 cm e previsto per montaggio in caso di modulo con schienale)

Rivestimento. In Pelle Frau®:

- Cuoio Saddle
- Cuoio Saddle Extra

Con cuciture a contrasto.

Mensole. Realizzate con piano in alluminio curvato e supporti verticali in acciaio finitura ruthenium. Disponibili in due dimensioni:

- 150 cm (prevista per moduli 2 posti e 3 posti)
- 190 cm (prevista per moduli large 2 posti e 3 posti)

Rivestimento. In Pelle Frau®:

- Cuoio Saddle
- Cuoio Saddle Extra

Con cuciture a contrasto.

It is possible to create symmetrical or asymmetrical compositions using 2 different height for armrests, an end top, a back unit and a cylindrical cushion support.

END UNIT AND BACK UNIT

It can be used to replace left or right armrests (end unit) or the backseats (back unit) in case of asymmetrical, modular or corner versions.

Units structure (available only for modules provided for). In curved aluminium and a central dividing panel in birch plywood.

Upholstery in:

- Saddle leather
 - Saddle Extra leather
- With contrast stitching.

ACCESSORIES AND COMPLEMENTS

CUSHIONS

Suggested optional back 65×65 cushions. Not included in the price. In goose down in two separate horizontal compartments to ensure differentiated and anatomical comfort. One backseat cushion per each backseat is recommended.

Cylindrical cushion. In goose feather. Available in two versions:

- 65 cm
- 75 cm

Upholstery. In Pelle Frau® leather or fabric:

- | | |
|----------------------|------------|
| - Color System Frau® | - Fabric A |
| - Heritage | - Fabric B |
| - Nest | - C.O.M. |
| - Soul | |

C.O.M. (Fabric/Mt. plain - Fabric/Mt. repeat)

65X65 cushion: 1,5-1,7

Cylindrical cushion 65 cm: 0,8-0,9

Cylindrical cushion 74 cm: 0,8-0,9

CUSHIONS SUPPORT

65×65 back cushion headrest support Made of a rod and a curved metal sheet. The support, that guarantees the right head support, is placed between the 65×65 cushions and backseat.

Upholstery. In Pelle Frau® leather:

- Color System Frau®
- Nest
- Soul

Cylindrical cushion support.

- 66 cm (suggested for 75 cm cylindrical cushion and provided for the modules with bench)

- 33 cm (suggested for 65 cm cylindrical cushion and provided for the modules with backrest)

Upholstery. In Pelle Frau® leather:

- Saddle
- Saddle Extra

With contrast stitching.

Shelves. Made of a moulded aluminium top with vertical support in steel with ruthenium finish. Available in two dimensions:

- 150 cm (provided for 2 and 3 seater module)
- 190 cm (provided for 2 and 3 large seater module)

Upholstery. In Pelle Frau® leather:

- Saddle
- Saddle Extra

With contrast stitching.

BRACCIOLI, MOBILE TERMINALE E MOBILE SCHIENALE / ARMRESTS, END UNIT AND BACK UNIT

È POSSIBILE REALIZZARE CONFIGURAZIONI SIMMETRICHE E ASIMMETRICHE UTILIZZANDO 2 BRACCIOLI DI DIVERSE ALTEZZE, UN MOBILE TERMINALE E UN MOBILE SCHIENALE.

IT IS POSSIBLE TO CREATE SYMMETRICAL OR ASYMMETRICAL COMPOSITIONS USING 2 DIFFERENT HEIGHT FOR ARMRESTS, AN END TOP AND A BACK UNIT.

BRACCIOLI E TERMINALI DISPONIBILI / AVAILABLE ARMRESTS OR END UNIT

HIGH ARM

LOW ARM

END UNIT

PIEDI / FEET H. 19 cm

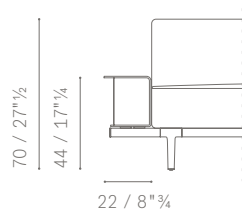
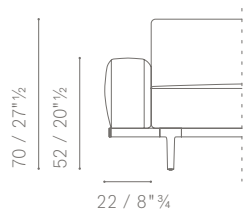
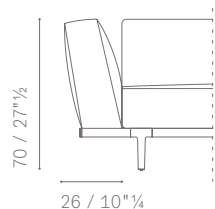

PIEDI / FEET H. 22 cm

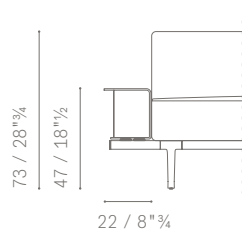
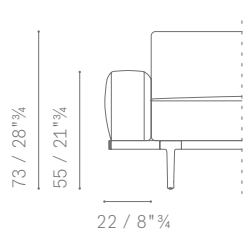
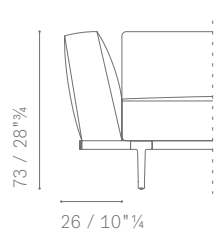

MOBILE SCHIENALE / BACK UNIT

DISPONIBILE IN SOSTITUZIONE AD UN CUSCINO SCHIENALE NELLE VERSIONI ASIMMETRICHE, COMPONIBILI O ANGOLARI.

IT CAN BE USED TO REPLACE THE BACKSEAT CUSHION IN CASE OF ASYMMETRICAL, MODULAR OR CORNER VERSIONS.

PIEDI / FEET H. 19 cm

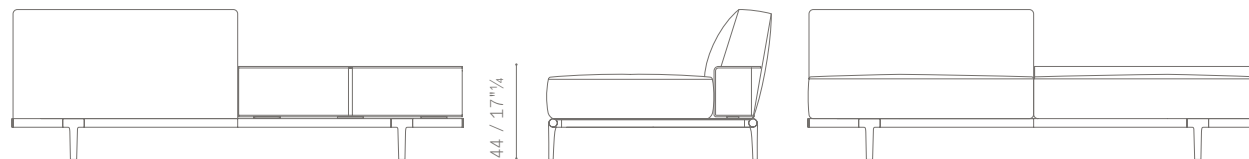

PIEDI / FEET H. 22 cm

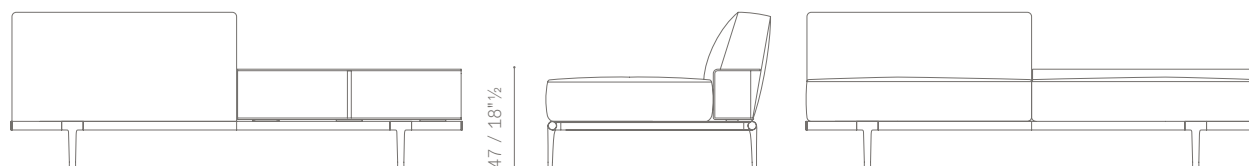

SI CONSIGLIA DI PREVEDERE UN CUSCINO PER
OGNI SCHIENALE.

ONE BACK CUSHION PER EACH BACKSEAT IS
RECOMMENDED.

CONFIGURAZIONE CONSIGLIATA / SUGGESTED CONFIGURATION

ESEMPIO: CONFIGURAZIONE DIVANO 2 POSTI / EXAMPLE: 2-SEATER SOFA CONFIGURATION

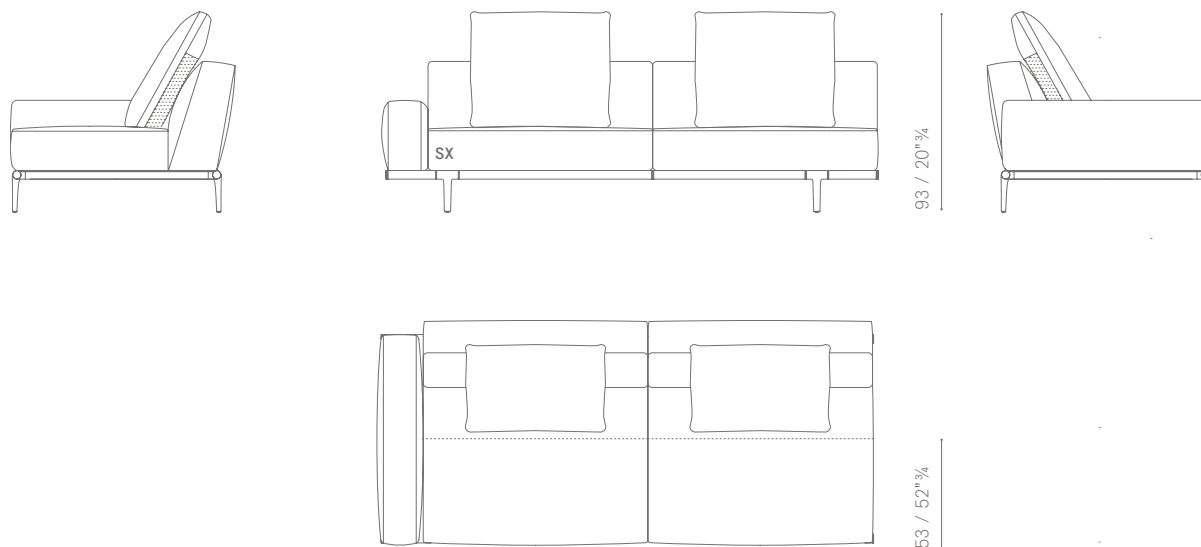

ESEMPIO: CONFIGURAZIONE DIVANO 2 POSTI ANGOLARE / EXAMPLE: CORNER 2-SEATER SOFA CONFIGURATION

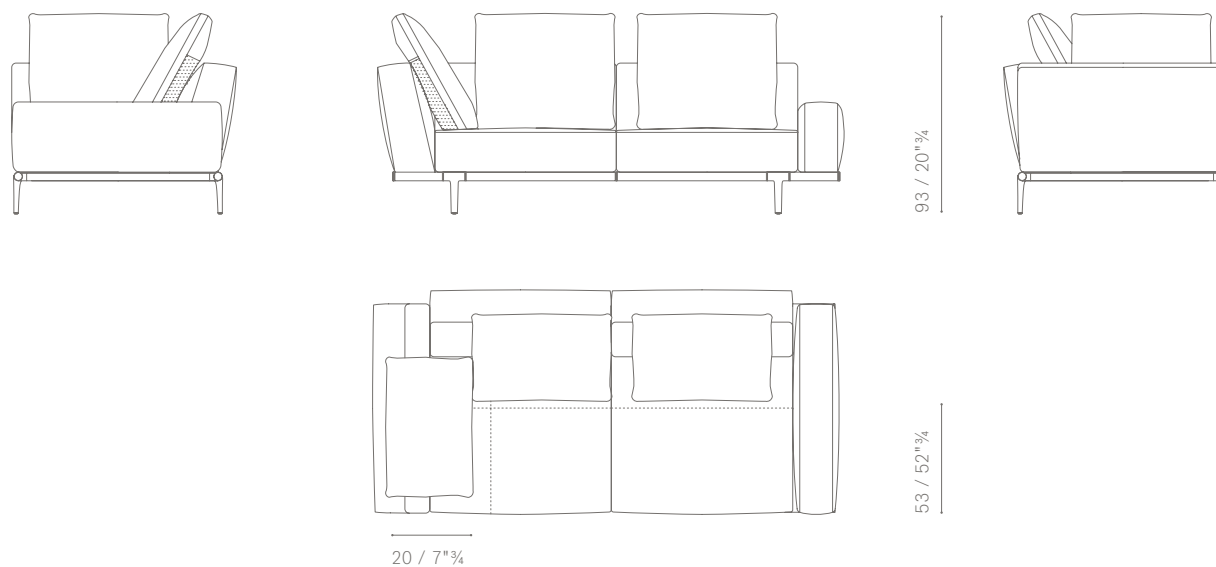

OPTIONAL: SUPPORTO CUSCINI CILINDRICI / OPTIONAL CYLINDRICAL CUSHIONS SUPPORT

NEL CASO DI MODULI SENZA BRACCIOLI È POSSIBILE AGGIUNGERE UN SUPPORTO PER L'APPOGGIO DEL CUSCINO CILINDRICO CHE PERMETTE DI CREARE ULTERIORI COMPOSIZIONI.

IN CASE OF MODULES WITHOUT ARMRESTS IT'S ALSO POSSIBLE TO PLACE AN OPTIONAL CYLINDRICAL CUSHION SUPPORT THAT ALLOW CREATING FURTHER COMPOSITIONS.

PIEDI / FEET H. 19 cm

PIEDI / FEET H. 22 cm

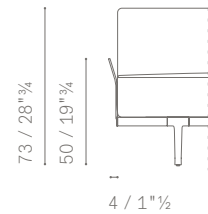
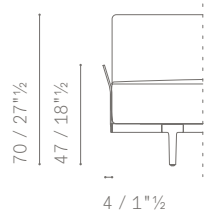
POSIZIONAMENTO DEL SUPPORTO DEL CUSCINO CILINDRICO / CYLINDRICAL CUSHIONS SUPPORT POSITIONING
DISPONIBILE IN DUE DIMENSIONI:

- 33 cm (consigliato per cuscino da 65 cm)
- 66 cm (consigliato per cuscino da 75 cm)

IT'S AVAILABLE IN TWO DIMENSIONS:

- 33 cm (suggested for 65 cm cushions)
- 66 cm (suggested for 75 cm cushions)

SUPPORTO DA 33 cm / 33 cm SUPPORT

previsto per montaggio in caso di modulo con schienale / *provided for the modules with backrest*

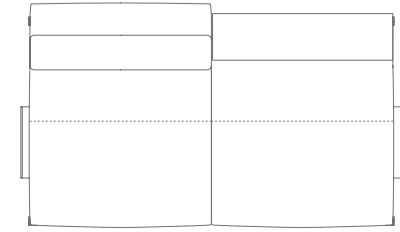
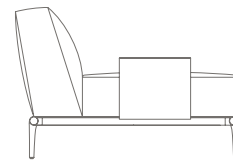
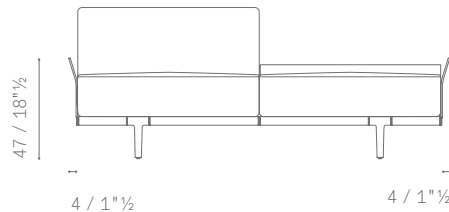
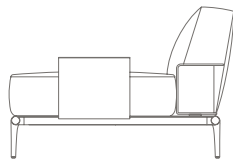
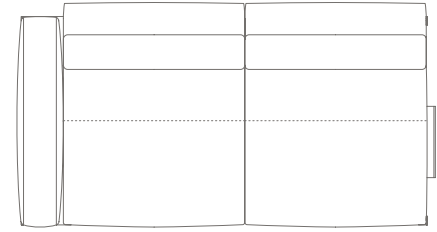
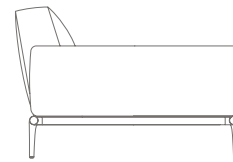
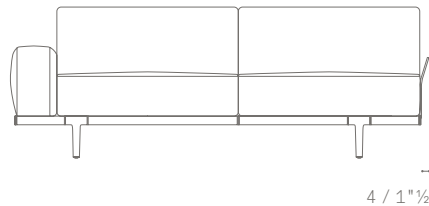
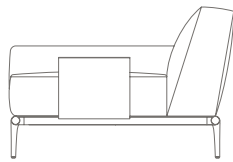
SUPPORTO DA 66 cm / 66 cm SUPPORT

previsto per montaggio in caso di modulo con panca / *provided for the modules with bench*

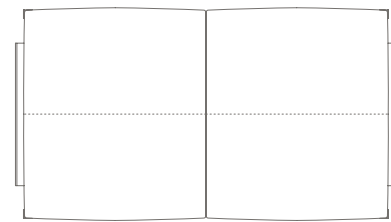
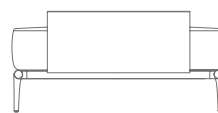
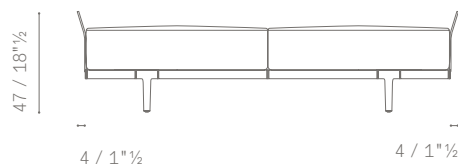
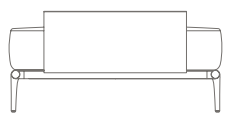
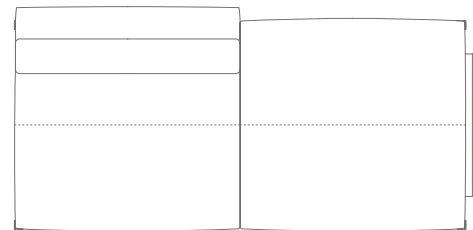
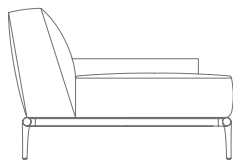
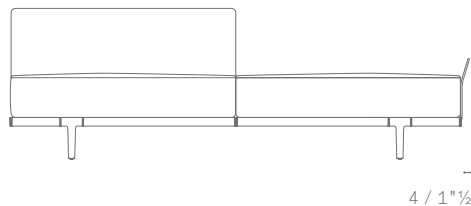
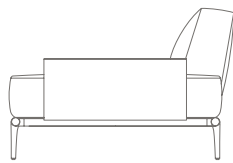

OPTIONAL: SUPPORTO POGGIATESTA PER CUSCINO SCHIENALE/ *OPTIONAL: BACK CUSHION HEADREST SUPPORT*

Da posizionare tra il cuscino 65×65 e lo schienale, garantisce il giusto supporto alla testa.
To place between the 65×65 cushion and the backseat. It guarantees the right head support.

**POSIZIONAMENTO SUPPORTO POGGIATESTA /
*HEADREST SUPPORT POSITIONING***

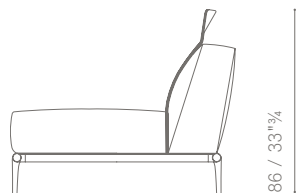

**POSIZIONE CUSCINO SCHIENALE 65X65 cm CON SUPPORTO POGGIATESTA /
*65×65 cm BACK CUSHION POSITION WITH HEADREST SUPPORT***

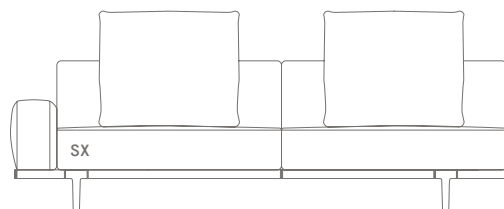
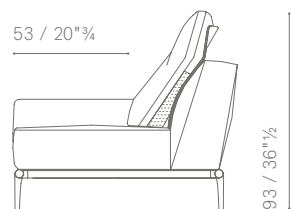

OPTIONAL: MENSOLE / OPTIONAL SHELVES

DISPONIBILI IN DUE DIMENSIONI / AVAILABLE IN TWO DIMENSIONS:

- 150 cm
- 190 cm

MENSOLA DA 150 cm / 150 cm SHELF

prevista per moduli 2 posti e 3 posti/ provided for 2 and 3 seater module

ESEMPIO: POSIZIONAMENTO MENSOLA SU DIVANO 2 POSTI / EXAMPLE: SHELF POSITIONING ON 2-SEATER SOFA

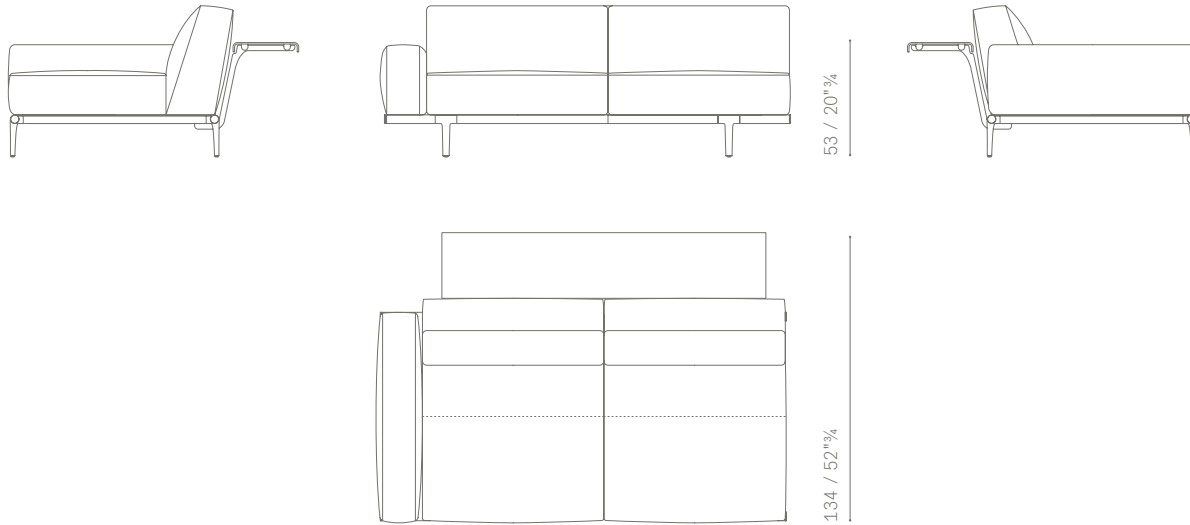

ESEMPIO: POSIZIONAMENTO MENSOLA SU DIVANO 3 POSTI / EXAMPLE: SHELF POSITIONING ON 3-SEATER SOFA

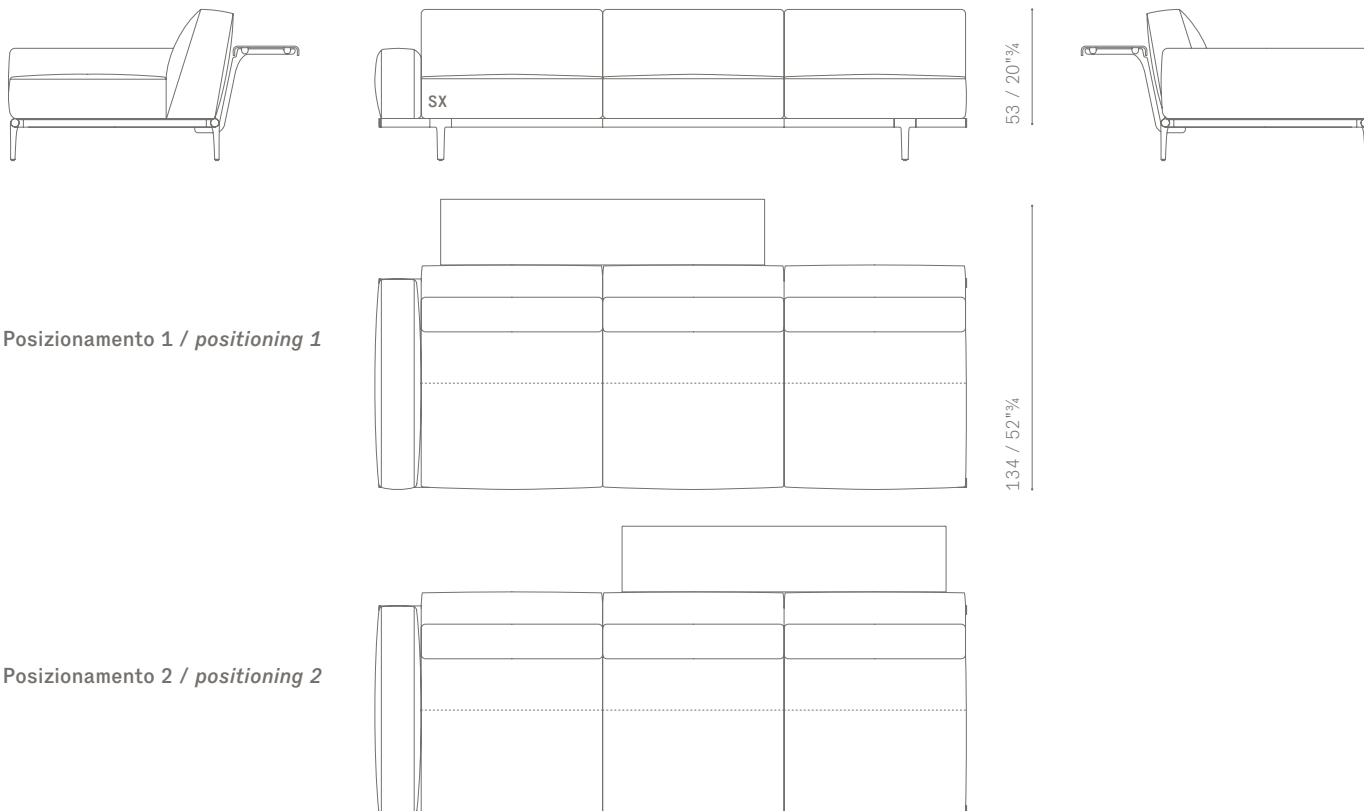

L'altezza è stata rilevata con piedi di 19 cm / The height was measured with a 19 cm feet

MENSOLA DA 190 cm / 190 cm SHELF

prevista per moduli large 2 posti e 3 posti / *provided for 2 and 3 large seater module*

ESEMPIO: POSIZIONAMENTO MENSOLA SU DIVANO 2 POSTI LARGE / *EXAMPLE: SHELF POSITIONING ON LARGE 2-SEATER SOFA*

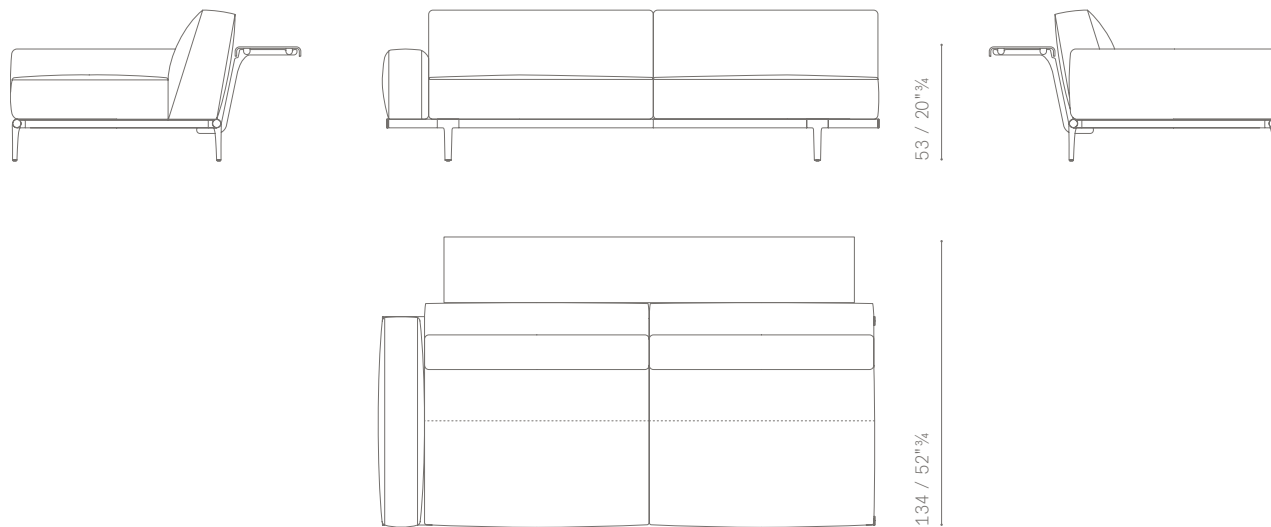

ESEMPIO: POSIZIONAMENTO MENSOLA SU DIVANO 3 POSTI LARGE / *EXAMPLE: SHELF POSITIONING ON LARGE 3-SEATER SOFA*

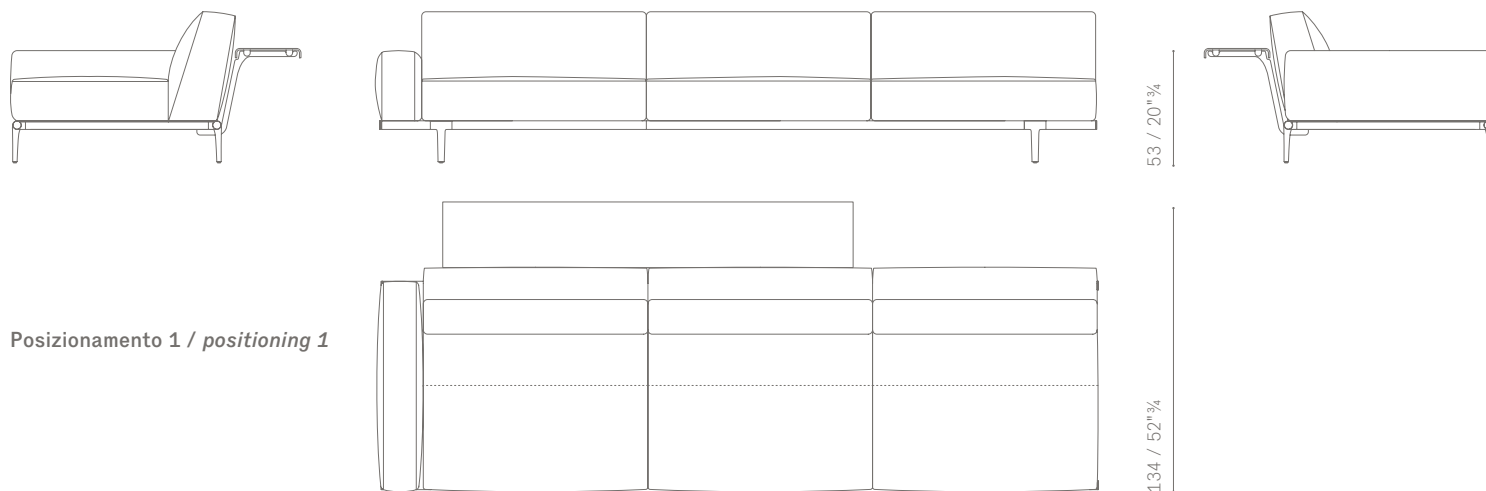

Posizionamento 1 / *positioning 1*

Posizionamento 2 / *positioning 2*

L'altezza è stata rilevata con piedi di 19 cm / *The height was measured with a 19 cm feet*

DIVANI SIMMETRICI E ASIMMETRICI / SYMMETRICAL AND ASYMMETRICAL SOFAS

DIVANI 2 POSTI
 2-SEATER SOFAS
 DIVANI 2 POSTI LARGE
 LARGE 2-SEATER SOFAS
 DIVANI 3 POSTI
 3 SEATER SOFAS
 DIVANI 3 POSTI LARGE
 LARGE 3-SEATER SOFAS

5614211

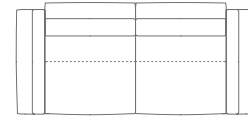

70 / 27"¹/₂
 40 / 15"³/₄

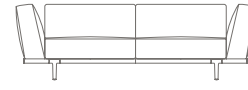
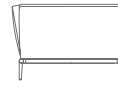

73 / 28"³/₄

168 / 66"¹/₄

104 / 41"

221 / 87"

5614211

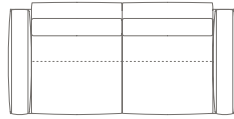

70 / 27"¹/₂
 52 / 20"¹/₂
 40 / 15"³/₄

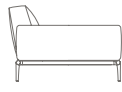

73 / 28"³/₄

168 / 66"¹/₄

104 / 41"

211 / 83"

5614218

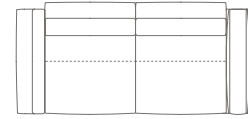

70 / 27"¹/₂
 52 / 20"¹/₂
 40 / 15"³/₄

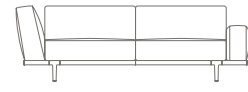
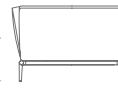

73 / 28"³/₄

168 / 66"¹/₄

104 / 41"

216 / 85"

5614216

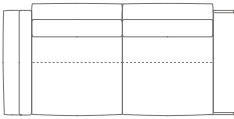

70 / 27"¹/₂
 44 / 17"¹/₄
 40 / 15"³/₄

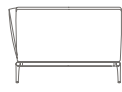

73 / 28"³/₄

168 / 66"¹/₄

104 / 41"

217 / 85"¹/₂

5614216

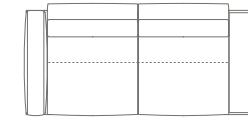

70 / 27"¹/₂
 52 / 20"¹/₂
 44 / 17"¹/₄



73 / 28"³/₄

168 / 66"¹/₄

104 / 41"

212 / 83"¹/₂

5614281

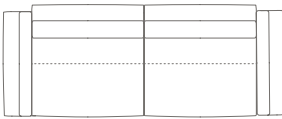

70 / 27"¹/₂
 40 / 15"³/₄

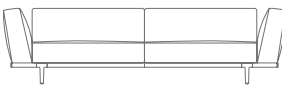
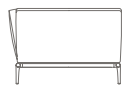

73 / 28"³/₄

208 / 82"

104 / 41"

261 / 102"³/₄

5614281

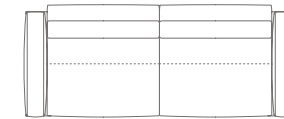

70 / 27"¹/₂
 52 / 20"¹/₂
 40 / 15"³/₄

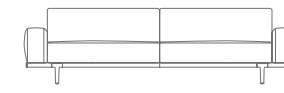

73 / 28"³/₄

208 / 82"

104 / 41"

251 / 98"³/₄

5614288

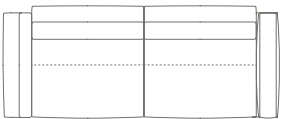

70 / 27"¹/₂
 52 / 20"¹/₂
 40 / 15"³/₄

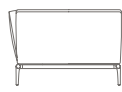

73 / 28"³/₄

208 / 82"

104 / 41"

256 / 100"³/₄

5614286

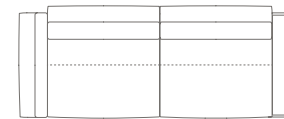

70 / 27"¹/₂
 44 / 17"¹/₄
 40 / 15"³/₄



73 / 28"³/₄

208 / 82"

104 / 41"

257 / 101"¹/₄

DIVANI SIMMETRICI E ASIMMETRICI / SYMMETRICAL AND ASYMMETRICAL SOFAS

5614286

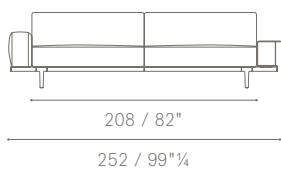
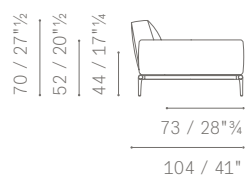
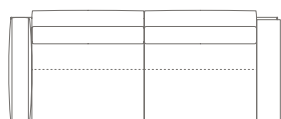

5614311

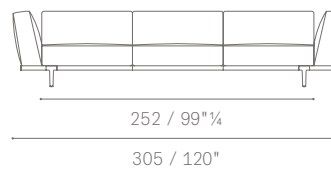
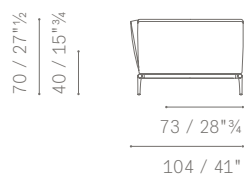
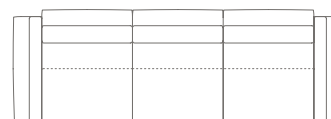

5614311

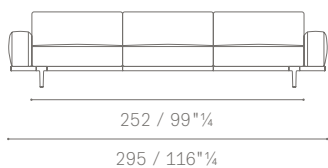
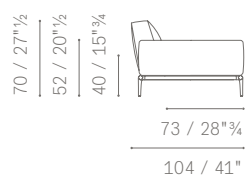
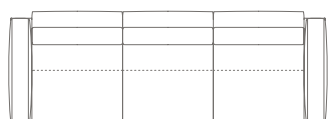

5614318

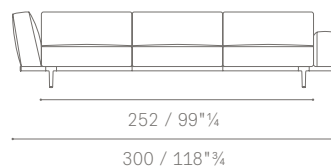
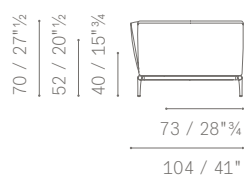
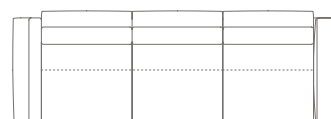

5614316

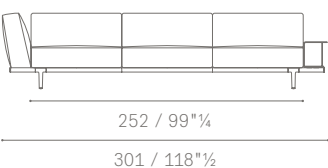
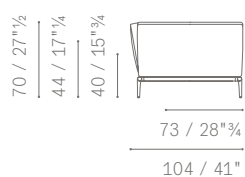
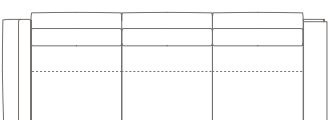

5614316

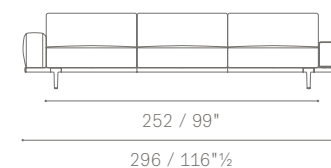
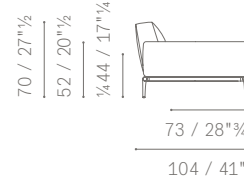
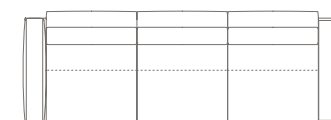

5614381

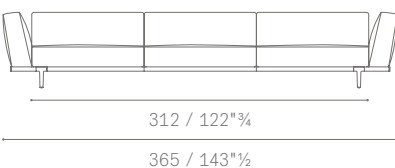
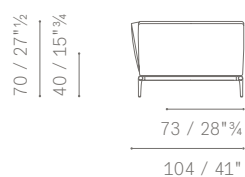

5614381

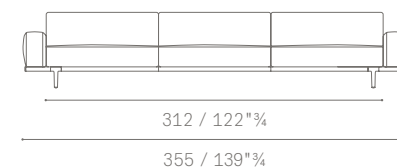
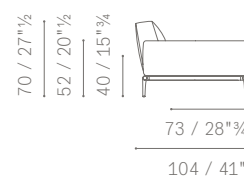
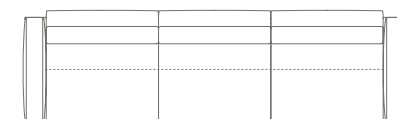

5614388

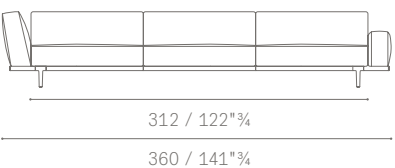
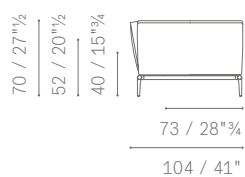

5614386

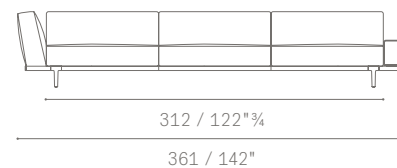
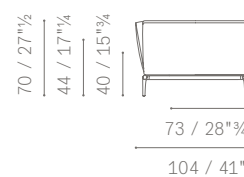
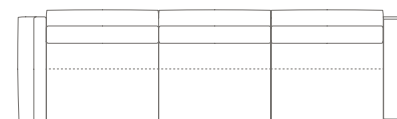

DIVANI SIMMETRICI E ASIMMETRICI / SYMMETRICAL AND ASYMMETRICAL SOFAS

5614386

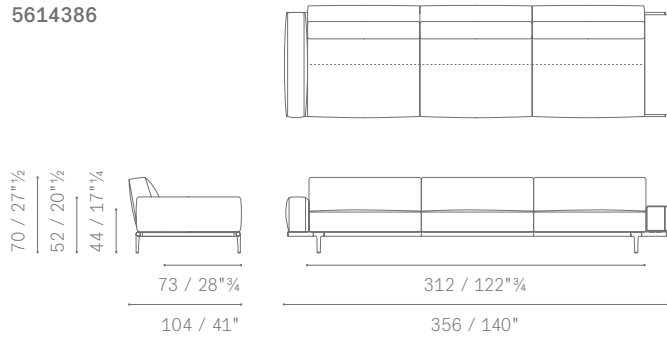

PANCHE E MODULI CON PANCA / BENCHES AND MODULES WITH BENCH

PANCHE
BENCHES

POLTRONA LARGE CON PANCA
LARGE ARMCHAIR WITH BENCH

DIVANI 2 POSTI CON PANCA
2-SEATER SOFA WITH BENCH

DIVANI 2 POSTI LARGE CON PANCA
LARGE 2-SEATER SOFA WITH BENCH

5614241

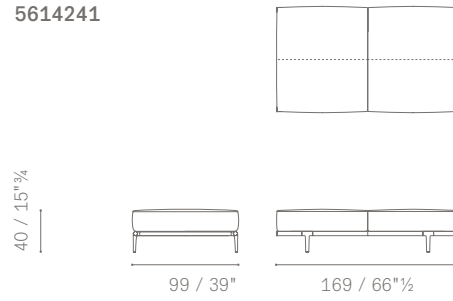

5614251

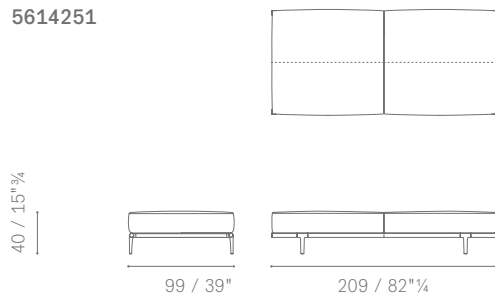

5614341

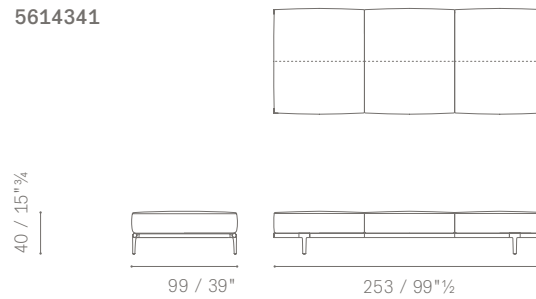

5614121

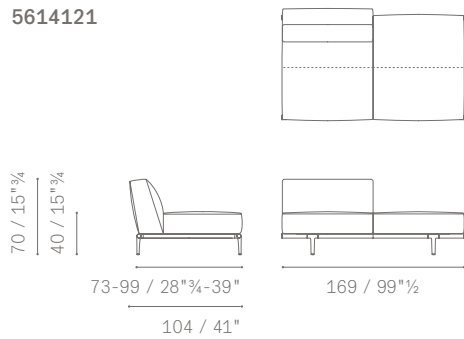

5614122

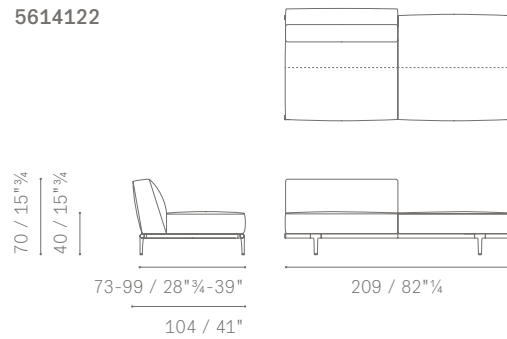

5614223

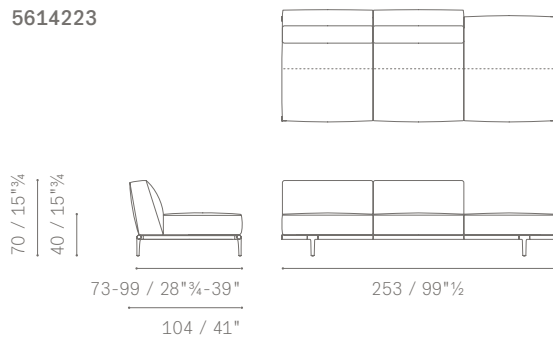

5614213

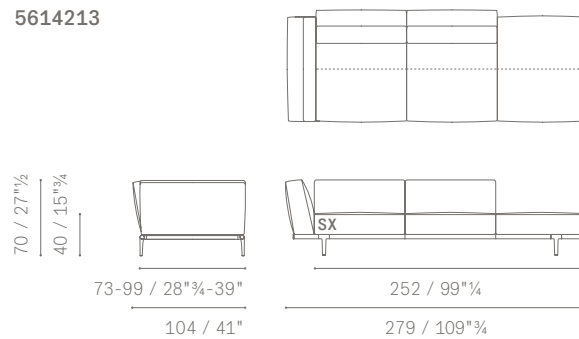

PANCHE E MODULI CON PANCA / BENCHES AND MODULES WITH BENCH

5614213

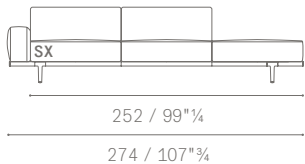
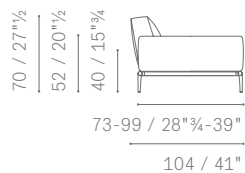
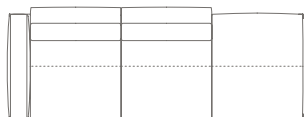

5614293

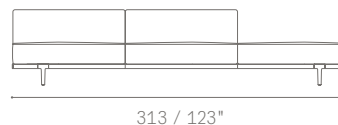
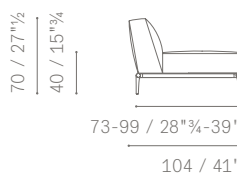
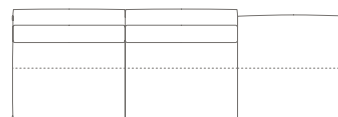

5614283

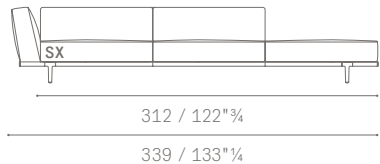
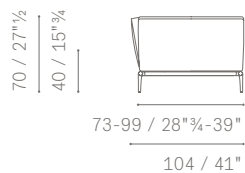
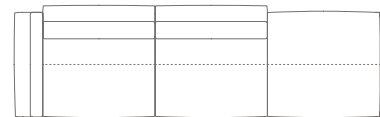

5614283

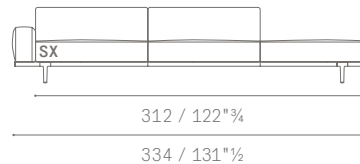
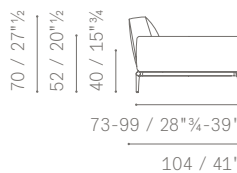
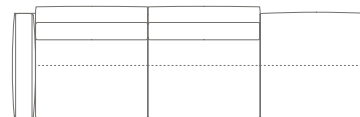

MODULI COMPONIBILI E TERMINALI / SECTIONAL MODULES AND SOFAS

DIVANI 2 POSTI COMPONIBILI
SECTIONAL 2-SEATER SOFAS
DIVANI 2 POSTI LARGE COMPONIBILI
SECTIONAL LARGE 2-SEATER SOFAS
DIVANI 3 POSTI COMPONIBILI
SECTIONAL 3 SEATER SOFAS
DIVANI 3 POSTI LARGE COMPONIBILI
SECTIONAL LARGE 3-SEATER SOFAS
CHAISE LONGUE COMPONIBILE
SECTIONAL CHAISE LONGUE

5614221

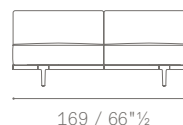
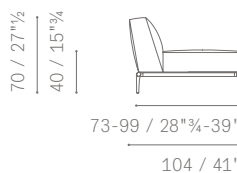
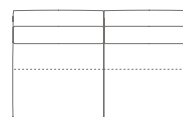

5614221

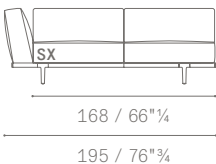
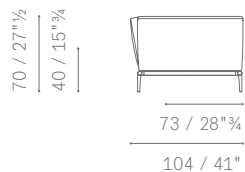
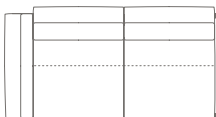

5614221

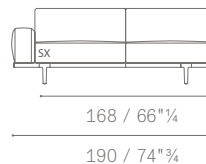
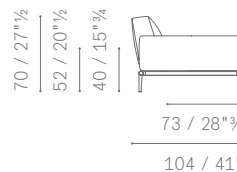
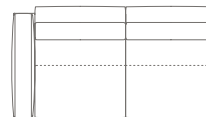

5614226

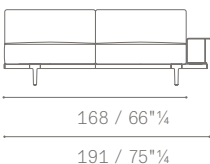
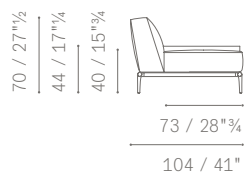
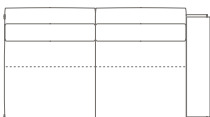

5614225

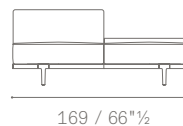
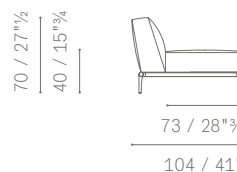

MODULI COMPONENTI E TERMINALI / SECTIONAL MODULES AND SOFAS

5614291

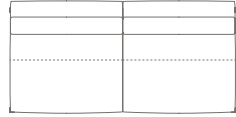

70 / 27¹/₂"
40 / 15³/₄"

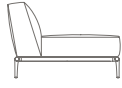

73 / 28³/₄"
104 / 41"

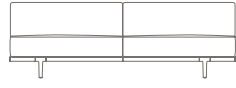

209 / 82¹/₄"

5614291

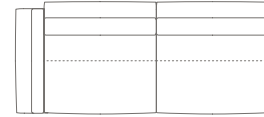

70 / 27¹/₂"
40 / 15³/₄"

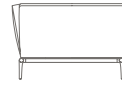

73 / 28³/₄"
104 / 41"

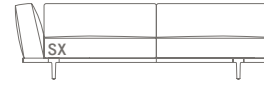

208 / 82"
235 / 92¹/₂"

5614291

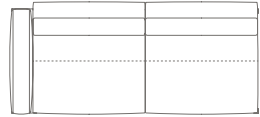

70 / 27¹/₂"
52 / 20¹/₂"
40 / 15³/₄"

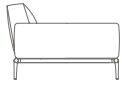

73 / 28³/₄"
104 / 41"



208 / 82"
230 / 90¹/₂"

5614296



70 / 27¹/₂"
44 / 21⁷/₄"
40 / 15³/₄"

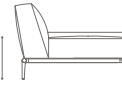

73 / 28³/₄"
104 / 41"



208 / 82"
231 / 91"

5614295



70 / 27¹/₂"
40 / 15³/₄"

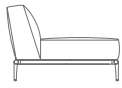

73 / 28³/₄"
104 / 41"

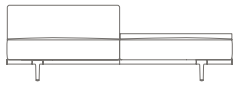

209 / 82¹/₄"

5614321

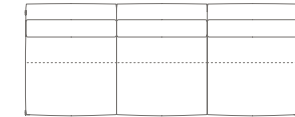

70 / 15³/₄"
40 / 15³/₄"



73-99 / 28³/₄-39"
104 / 41"

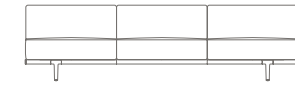

253 / 99¹/₂"

5614321

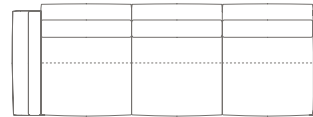

70 / 27¹/₂"
40 / 15³/₄"

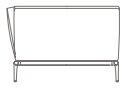

73 / 28³/₄"
104 / 41"

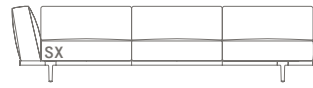

252 / 99¹/₄"
279 / 109³/₄"

5614321

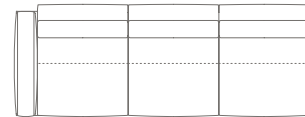

70 / 27¹/₂"
52 / 20¹/₂"
40 / 15³/₄"

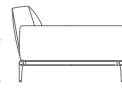

73 / 28³/₄"
104 / 41"

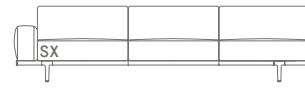

252 / 99¹/₄"
274 / 107³/₄"

5614326

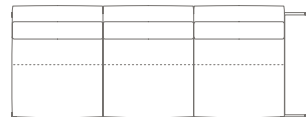

70 / 27¹/₂"
44 / 21⁷/₄"
40 / 15³/₄"

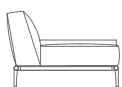

73 / 28³/₄"
104 / 41"

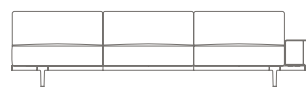

252 / 99¹/₄"
275 / 108¹/₄"

5614325

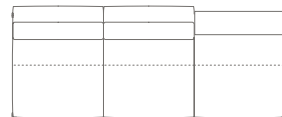

70 / 27¹/₂"
44 / 17¹/₄"
40 / 15³/₄"



73 / 28³/₄"
104 / 41"



253 / 99¹/₂"

MODULI COMPONENTI E TERMINALI / SECTIONAL MODULES AND SOFAS

5614325

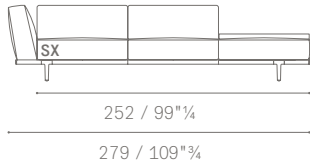
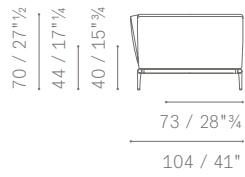
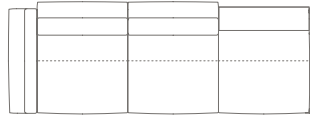

5614325

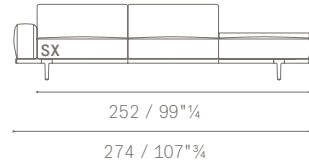
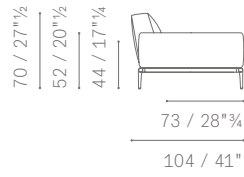
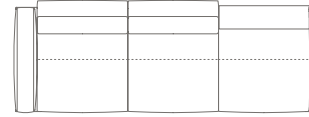

5614317

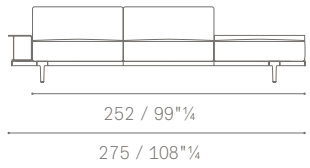
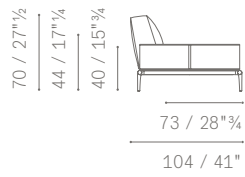
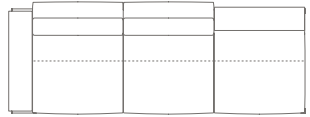

5614391

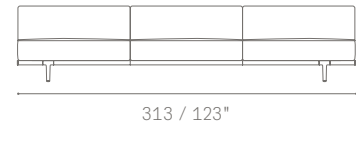
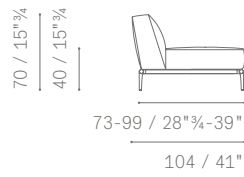
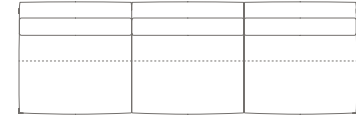

5614391

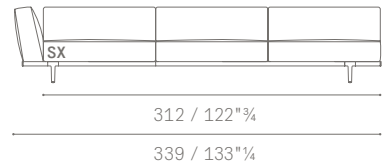
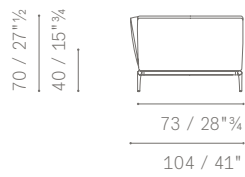
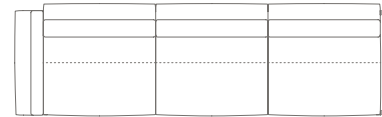

5614391

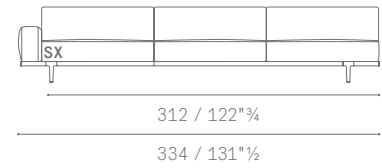
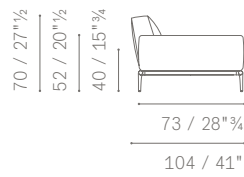
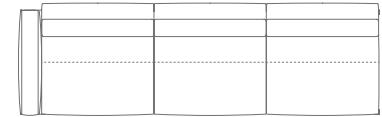

5614396

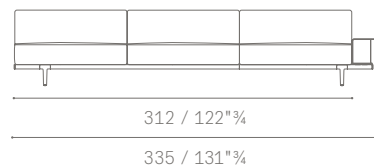
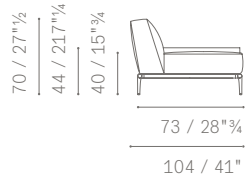
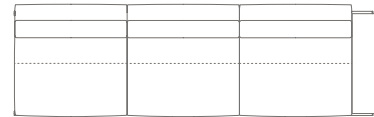

5614395

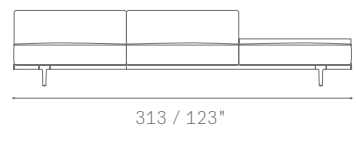
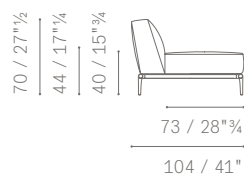
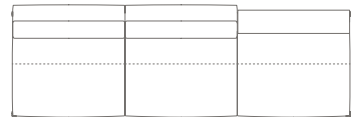

5614395

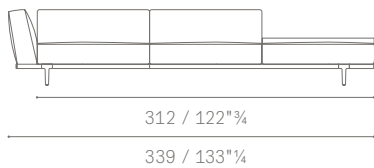
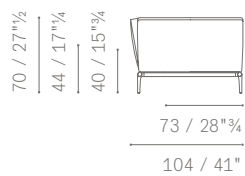
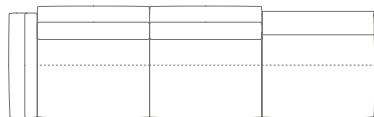

5614395

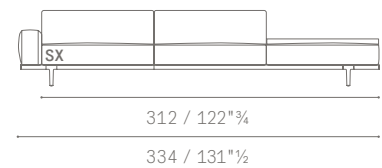
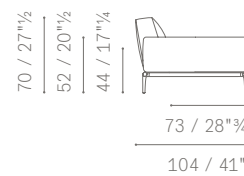
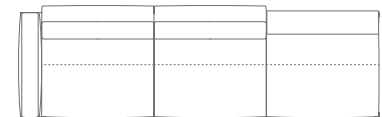

MODULI COMPONIBILI E TERMINALI / SECTIONAL MODULES AND SOFAS

5614387

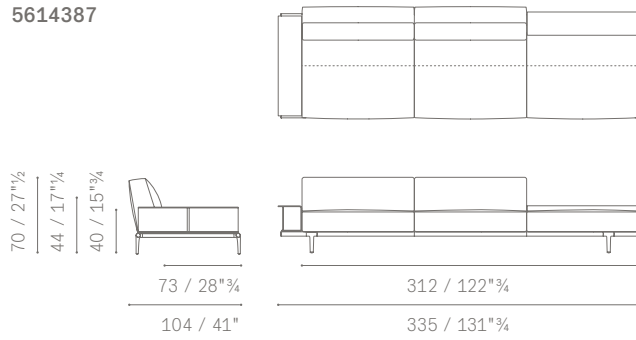

5614146

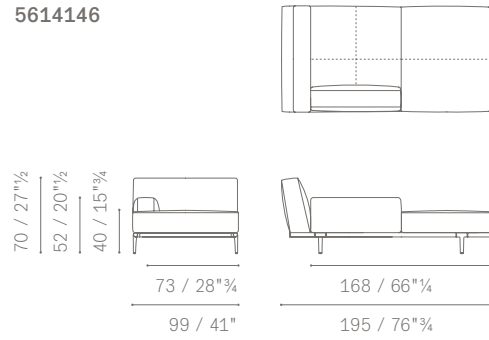

MODULI E DIVANI ANGOLARI / CORNER MODULES AND SOFAS

POLTRONA ANGOLARE CON PANCA
CORNER ARMCHAIR WITH BENCH
DIVANI 2 POSTI ANGOLARI
CORNER 2-SEATER SOFAS
DIVANI 2 POSTI LARGE ANGOLARI
CORNER LARGE 2-SEATER SOFAS
DIVANI 3 POSTI ANGOLARI
CORNER 3 SEATER SOFAS
DIVANI 3 POSTI LARGE ANGOLARI
CORNER LARGE 3-SEATER SOFAS

5614124

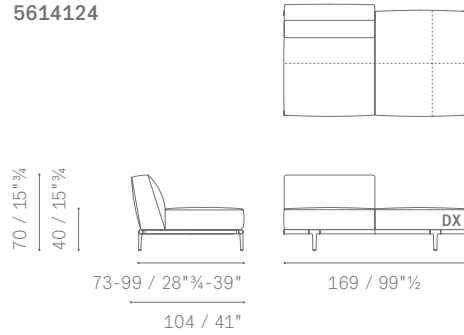

5614201

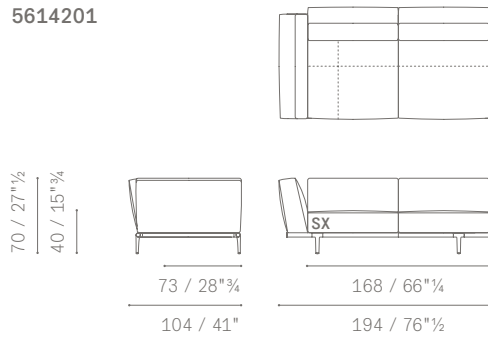

5614201

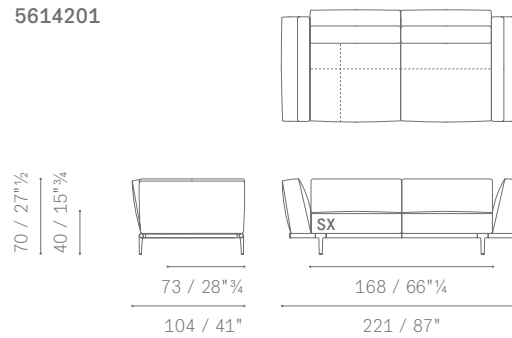

5614201

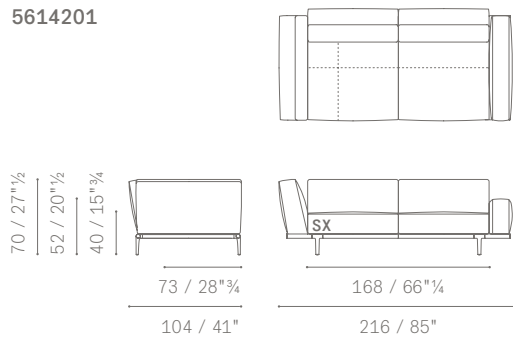

5614206

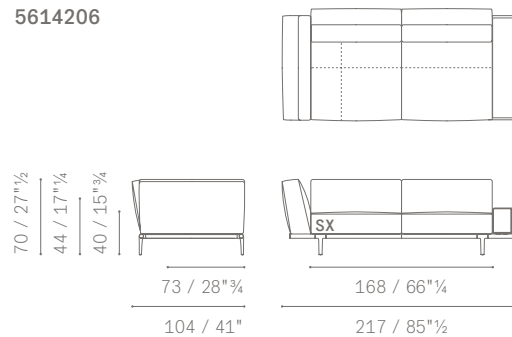

5614236

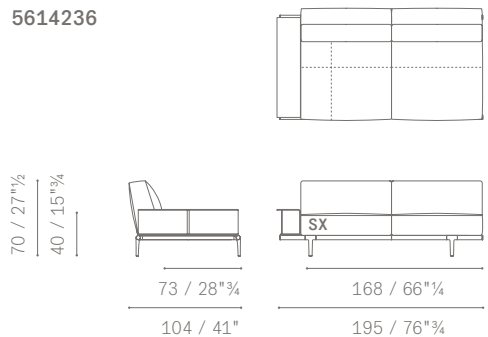

5614236

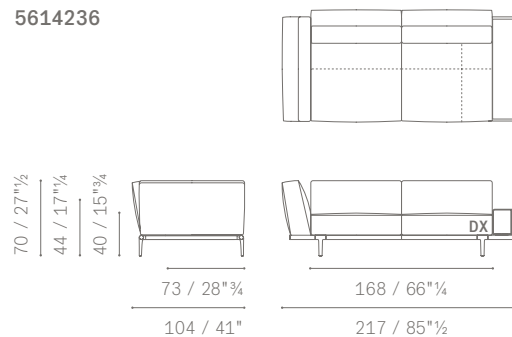

MODULI E DIVANI ANGOLARI / CORNER MODULES AND SOFAS

5614236

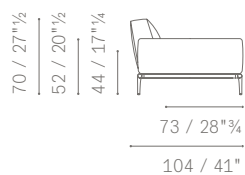
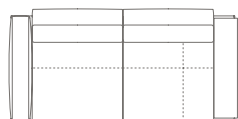

73 / 28 3/4"

104 / 41"

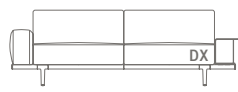

168 / 66 1/4"

212 / 83 1/2"

5614203

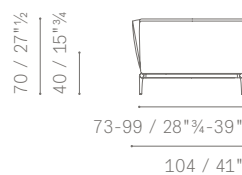
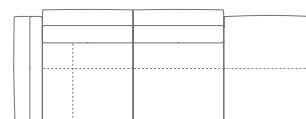

73-99 / 28 3/4-39"

104 / 41"

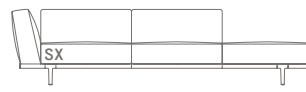

252 / 99 1/4"

279 / 109 3/4"

5614246

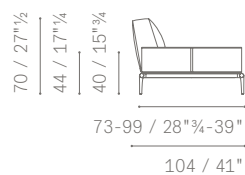
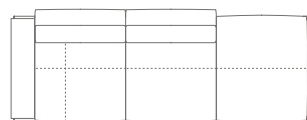

73-99 / 28 3/4-39"

104 / 41"



252 / 99 1/4"

275 / 108 3/4"

5614271

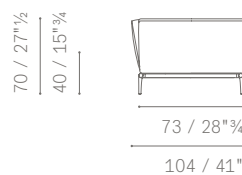
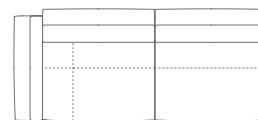

73 / 28 3/4"

104 / 41"

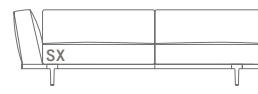

208 / 82"

235 / 92 1/2"

5614271

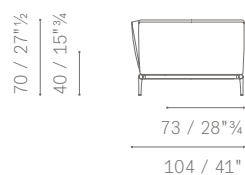
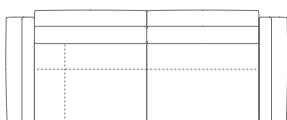

73 / 28 3/4"

104 / 41"

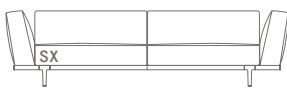

208 / 82"

261 / 102 3/4"

5614271

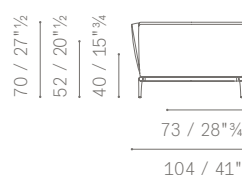
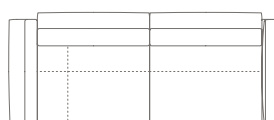

73 / 28 3/4"

104 / 41"



208 / 82"

256 / 100 3/4"

5614276

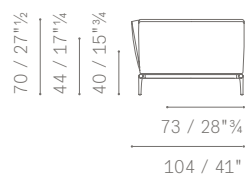
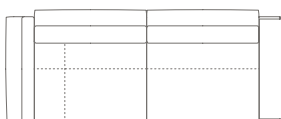

73 / 28 3/4"

104 / 41"

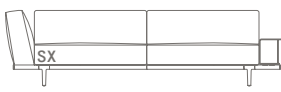

208 / 82"

257 / 101 3/4"

5614256

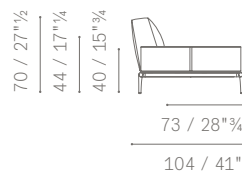
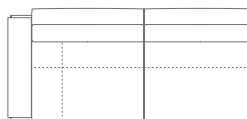

73 / 28 3/4"

104 / 41"

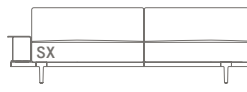

208 / 82"

231 / 91"

5614256

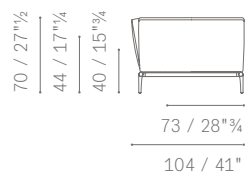
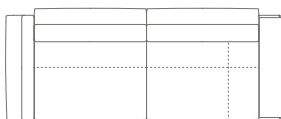

73 / 28 3/4"

104 / 41"

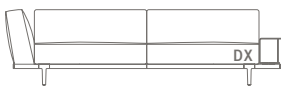

208 / 82"

257 / 101 3/4"

5614256

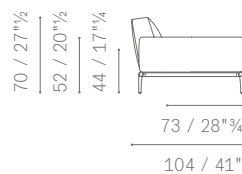
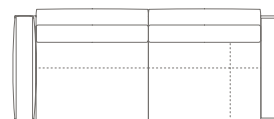

73 / 28 3/4"

104 / 41"



208 / 82"

252 / 99 1/4"

MODULI E DIVANI ANGOLARI / CORNER MODULES AND SOFAS

5614275

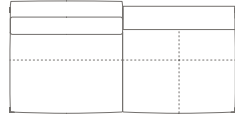

70 / 27"^{1/2}
40 / 15"^{3/4}

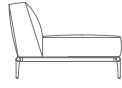

73 / 28"^{3/4}
104 / 41"

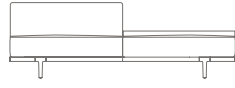

209 / 82"^{1/4}

5614294

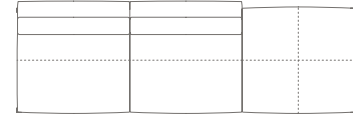

70 / 27"^{1/2}
40 / 15"^{3/4}



73-99 / 28"^{3/4}-39"
104 / 41"



313 / 123"

5614294

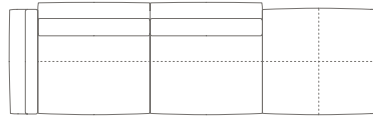

70 / 27"^{1/2}
40 / 15"^{3/4}

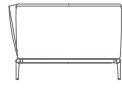

73-99 / 28"^{3/4}-39"
104 / 41"

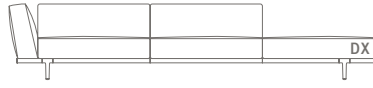

312 / 122"^{3/4}
339 / 133"^{3/4}

5614294

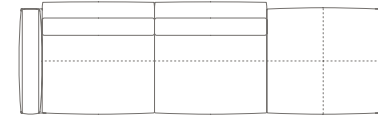

70 / 27"^{1/2}
52 / 20"^{1/2}
40 / 15"^{3/4}



73-99 / 28"^{3/4}-39"
104 / 41"

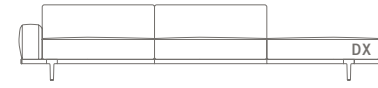

312 / 122"^{3/4}
334 / 131"^{1/2}

5614273

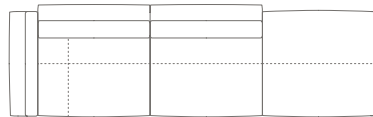

70 / 27"^{1/2}
40 / 15"^{3/4}

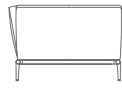

73-99 / 28"^{3/4}-39"
104 / 41"

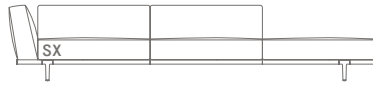

312 / 122"^{3/4}
339 / 133"^{3/4}

5614266

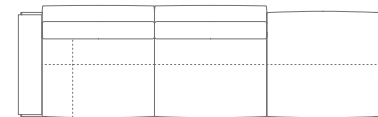

70 / 27"^{1/2}
44 / 17"^{1/4}
40 / 15"^{3/4}

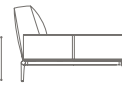

73-99 / 28"^{3/4}-39"
104 / 41"

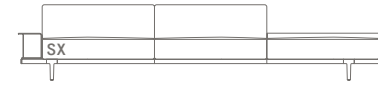

312 / 122"^{3/4}
335 / 131"^{3/4}

5614301

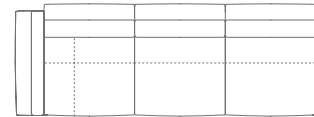

70 / 27"^{1/2}
40 / 15"^{3/4}

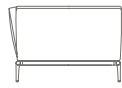

73 / 28"^{3/4}
104 / 41"

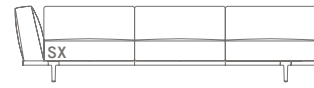

252 / 99"^{1/4}
279 / 109"^{3/4}

5614301

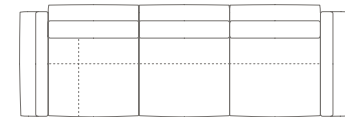

70 / 27"^{1/2}
40 / 15"^{3/4}

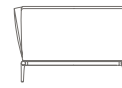

73 / 28"^{3/4}
104 / 41"

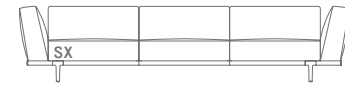

252 / 99"^{1/4}
305 / 120"

5614301

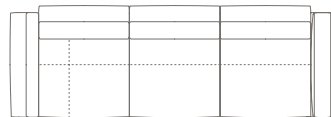

70 / 27"^{1/2}
52 / 20"^{1/2}
40 / 15"^{3/4}

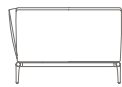

73 / 28"^{3/4}
104 / 41"

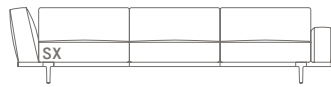

252 / 99"^{1/4}
300 / 118"^{3/4}

5614306



70 / 27"^{1/2}
44 / 17"^{1/4}
40 / 15"^{3/4}

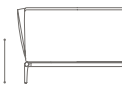

73 / 28"^{3/4}
104 / 41"

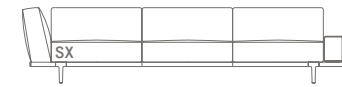

252 / 99"^{1/4}
301 / 118"^{1/2}

MODULI E DIVANI ANGOLARI / CORNER MODULES AND SOFAS

5614336

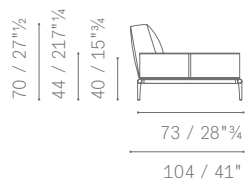
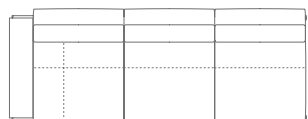

5614336

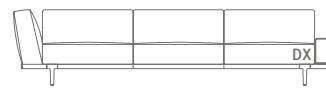
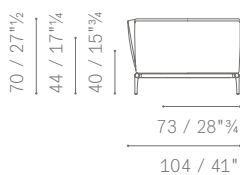
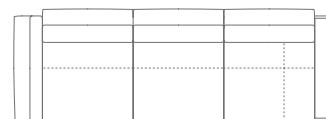

5614336

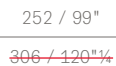
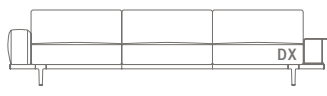
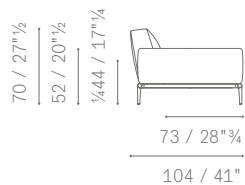
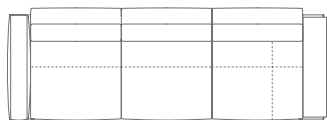

5614305

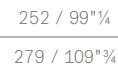
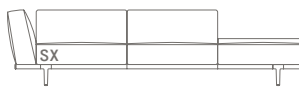
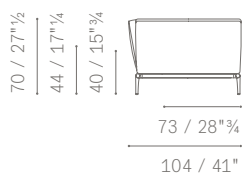
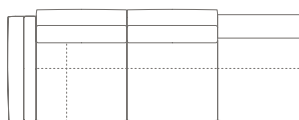

5614371

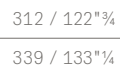
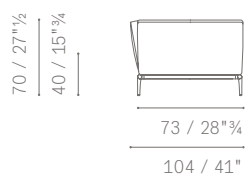
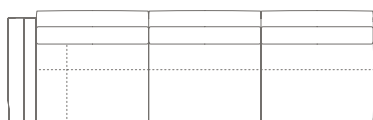

5614371

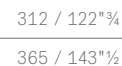
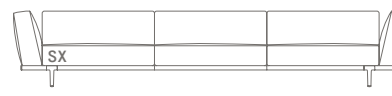
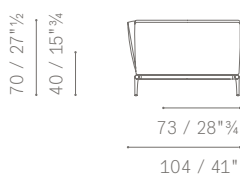
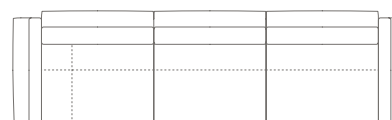

5614371

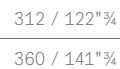
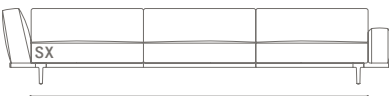
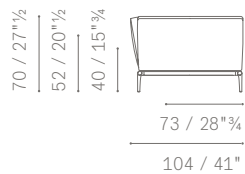
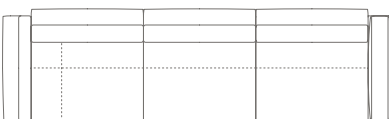

5614376

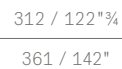
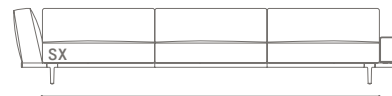
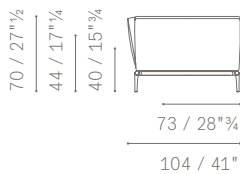
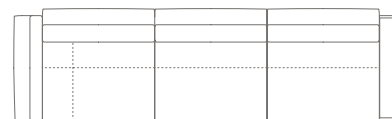

5614356

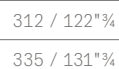
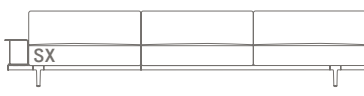
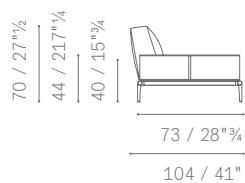
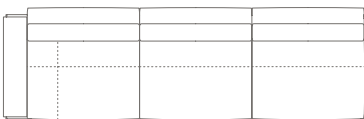

5614356

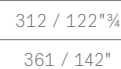
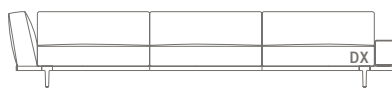
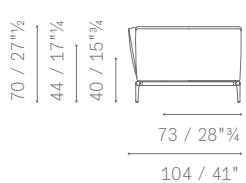
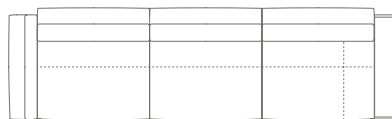

MODULI E DIVANI ANGOLARI / CORNER MODULES AND SOFAS

5614356

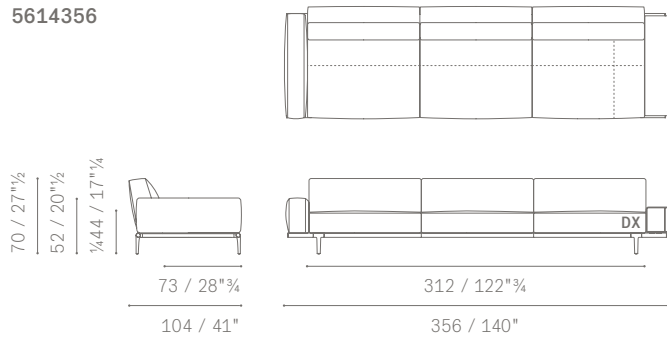

5614375

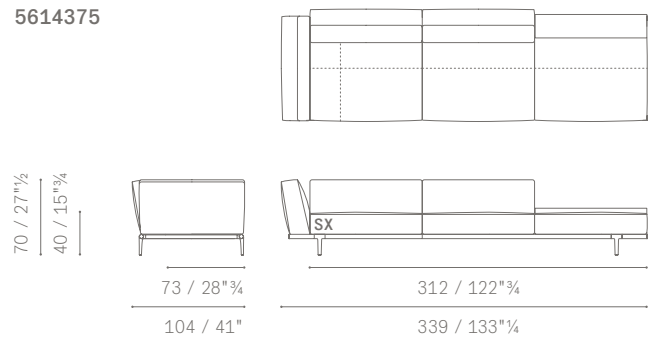

5614385

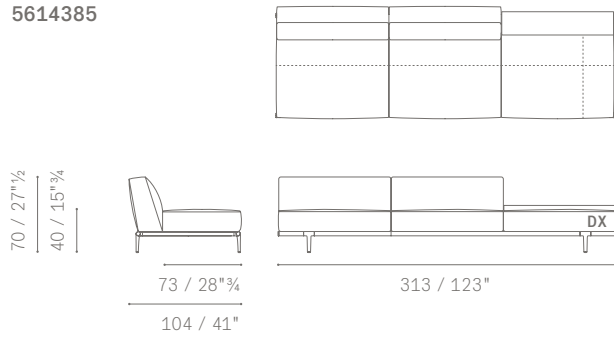

5614385

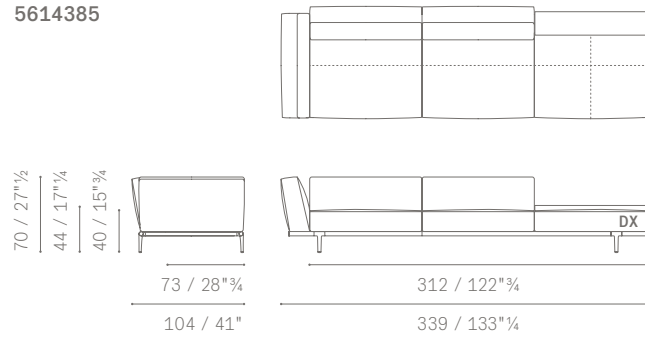

5614385

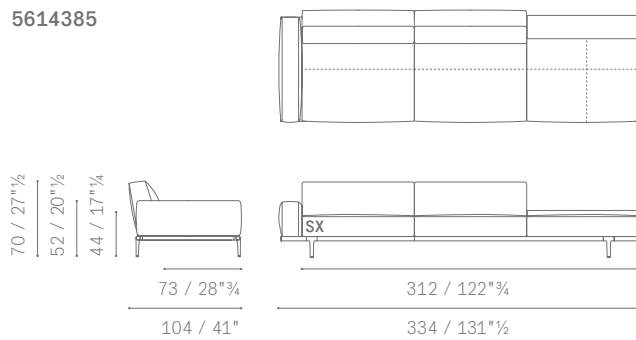

CUSCINI / CUSHIONS

CUSCINO SCHIENALE
BACK CUSHION
CUSCINI CILINDRICI
CYLINDRICAL CUSHIONS

5614565

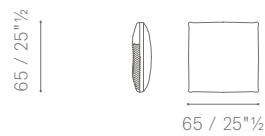

5614576

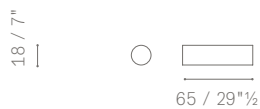

5614577



ACCESSORI E COMPLEMENTI / ACCESSORIES AND FURNISHING UNITS

SUPPORTO POGGIATESTA
HEADREST SUPPORT
SUPPORTI PER CUSCINI
CUSHIONS SUPPORT
MENSOLE
SHELVES

5614596

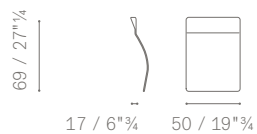

5614541

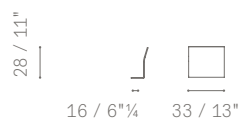

5614540



5614430

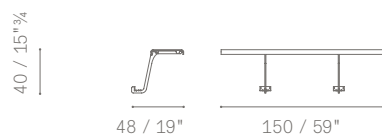

5614431

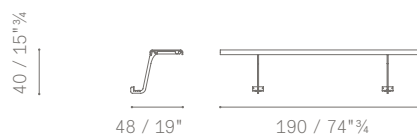

ESEMPIO DI COMPOSIZIONE 1 / LAYOUT EXAMPLE NO. 1

5614146 Sectional chaise longue
5614266 Corner large 2 seater sofa with bench and corner end unit dx-sx
suggested extra cushions
n. 3 5614565 Back cushions 65×65

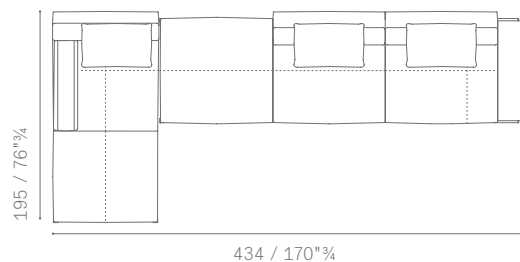

ESEMPIO DI COMPOSIZIONE 2 / LAYOUT EXAMPLE NO. 2

5614266 Corner large 2 seater sofa with bench and corner end unit dx-sx
5614293 Large armless 2 seater sofa with bench
suggested extra cushions
n. 4 5614565
Back cushions 65×65

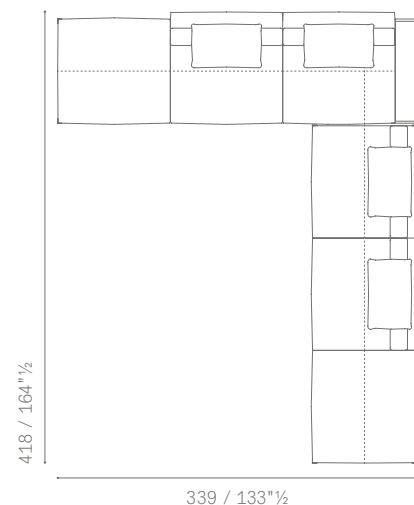

ESEMPIO DI COMPOSIZIONE 3 / LAYOUT EXAMPLE NO. 3

5614321 3 seater sofa 1 low arm dx-sx
5614294 Large 2 seater sofa 1 low arm with corner bench dx- sx
suggested extra cushions
n. 3 5614565 Back cushions 65×65

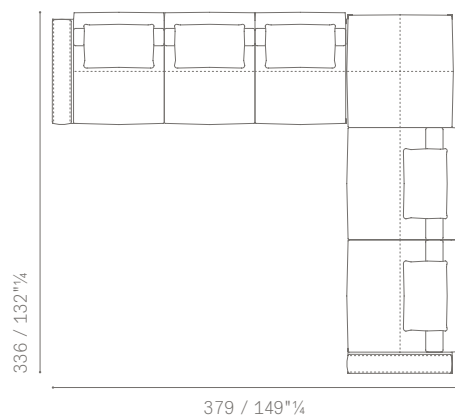

ESEMPIO DI COMPOSIZIONE 4 / LAYOUT EXAMPLE NO. 4

5614325 3 seater sofa 1 low arm dx-sx with back unit
5614146 Sectional chaise longue 1 low arm
5614430 Shelf 150
suggested extra cushions
n. 3 5614565 Back cushions 65×65

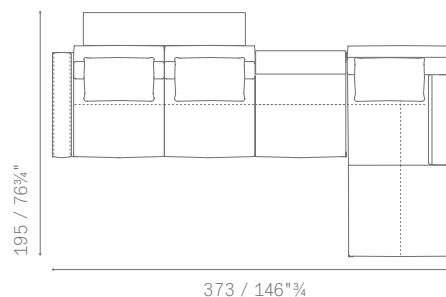

ESEMPIO DI COMPOSIZIONE 5 / LAYOUT EXAMPLE NO. 5

5614295 Large armless 2 seater sofa with backseat unit
5614371 Corner large 3 seater sofa 1 low arm
suggested extra cushions
n. 5 5614565 Back cushions 65×65

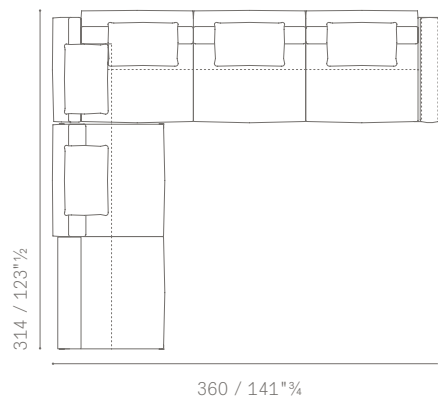

ESEMPIO DI COMPOSIZIONE 6 / LAYOUT EXAMPLE NO. 6

5614291 Large 2-seater sofa 1 low arm
5614375 Corner large 3-seater sofa sx without armrests with back unit
suggested extra cushions
n. 5 5614565 Back cushions 65×65

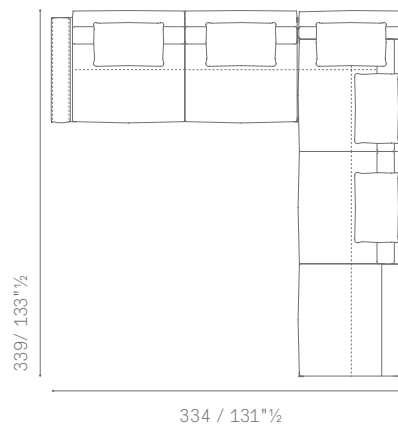

ESEMPIO DI COMPOSIZIONE 7 / LAYOUT EXAMPLE NO. 7

5614385 Large 3 seater sofa 1 low arm with corner back unit dx
 5614291 Large 2 seater sofa 1 high arm dx
 suggested extra cushions
 n. 4 5614565 back cushions 65×65

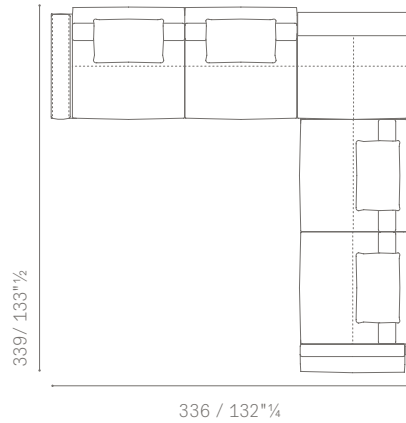
**ESEMPIO DI COMPOSIZIONE 8 / LAYOUT EXAMPLE NO. 8**

5614291 Large 2 seater sofa 1 low arm sx
 5614271 Corner large 2 seater sofa sx with 1 low arm
 suggested extra cushions
 n. 5 5614565 back cushions 65×65

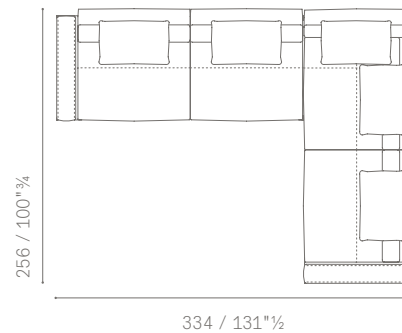
**ESEMPIO DI COMPOSIZIONE 9 / LAYOUT EXAMPLE NO. 9**

5614291 Large 2 seater sofa 1 low arm dx
 5614273 Corner large 2 seater sofa dx with bench sx
 5614431 Shelf 190
 suggested extra cushions
 n. 5 5614565 back cushions 65×65

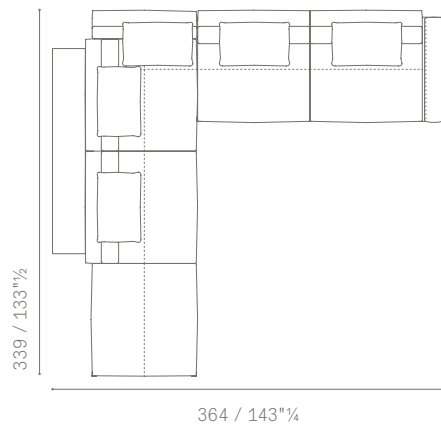
**ESEMPIO DI COMPOSIZIONE 10 / LAYOUT EXAMPLE NO. 10**

5614146 Sectional chaise longue 1 low arm sx
 5614291 Large 2 seater sofa 1 high arm dx
 suggested extra cushions
 n. 3 5614565 back cushions 65×65

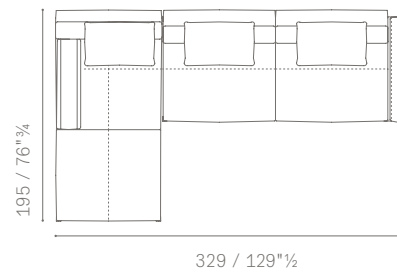
**ESEMPIO DI COMPOSIZIONE 11 / LAYOUT EXAMPLE NO. 11**

5614375 Large 3 seater sofa corner dx with back unit sx
 5614121 Armchair with bench dx
 5614540 Cylindrical cushion support 66 - 5614431 Shelf 150
 suggested extra cushions
~~n. 3~~ 5614565 back cushions 65×65
 n. 1 5614577 cylindrical cushion 75

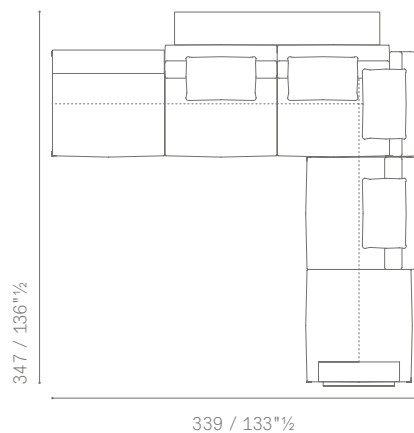
**ESEMPIO DI COMPOSIZIONE 12 / LAYOUT EXAMPLE NO. 12**

5614296 Large armless 2 seater sofa with end unit dx
 5614271 Corner armless large 2 seater sofa sx
 5614295 Large armless 2 seater sofa with back unit dx
 suggested extra cushions
~~n. 5~~ 5614565 back cushions 65×65

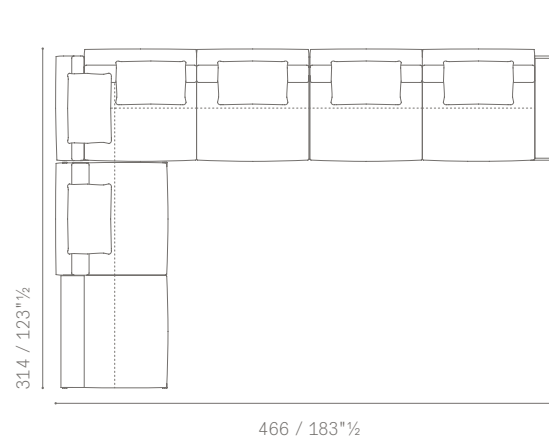

ESEMPIO DI COMPOSIZIONE 14 / LAYOUT EXAMPLE NO. 13

5614356 Large armless 3 seater sofa with corner end unit dx
5614291 Large armless 2 seater sofa
n. 2 **5614541** Cylindrical cushion support 33
suggested extra cushions
n. 5 **5614565** back cushions 65×65
n. 2 **5614576** cylindrical cushion 65

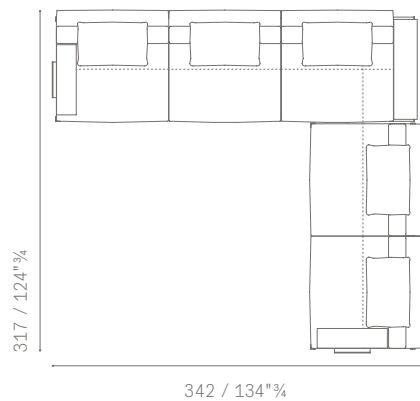

ESEMPIO DI COMPOSIZIONE 14 / LAYOUT EXAMPLE NO. 14

5614371 Corner large 3 seater sofa dx with 1 low arm sx
5614251 Large 2 seater bench
5614540 Cylindrical cushion support 66
suggested extra cushions
n. 4 **5614565** back cushions 65×65
n. 1 **5614577** cylindrical cushion 75

