

FLEXFORM



PICO OUTDOOR *DESIGN CENTER 2020*

TABLES

FLEXFORM Spa

Via Einaudi 23/25 20821 Meda (MB) Italy | Tel. +39 0362 3991 | info@flexform.it | www.flexform.it

PICO OUTDOOR | *DESIGN CENTER* | 2020

TABLE

Structure in aluminum with epoxy powder-coat finish in white 100, wine red 405, khaki green 705, grey, burnished or with embossed lacquered finish in white 300, sand 310, brick 320 and sage green 330

Elevated top in solid iroko slats, natural finish, stained grey, stained brown, or lacquered white finish. Supports and screws in 316 stainless steel, spacers in die-cast Zama, epoxy powder-coated with transparent finish. Or in the following types of stone: Lava, Porphyry, Cardoso, Beola Argentata. With stone tops, there is a painted plywood underpanel

Recessed top in solid iroko slats, natural finish, stained grey, stained brown, or lacquered white finish

Legs in cast aluminum with epoxy powder-coat finish in the following colors: white 100, wine red 405, khaki green 705, grey, burnished or with embossed lacquered finish in white 300, sand 310, brick 320 and sage green 330

Rest on tips made of thermoplastic material

Cover in waterproof material; cover is upon request, with upcharge

COD. 0283G4

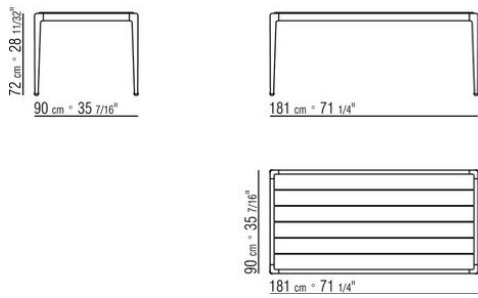

COD. 0283G5

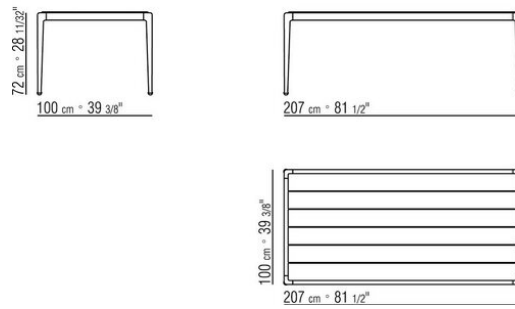

COD. 0283G6

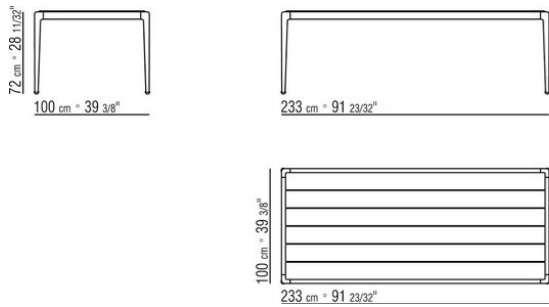

COD. 0283L0

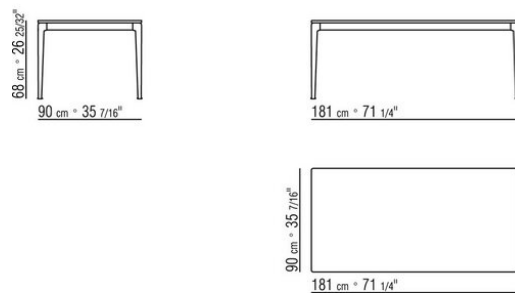

COD. 0283L1

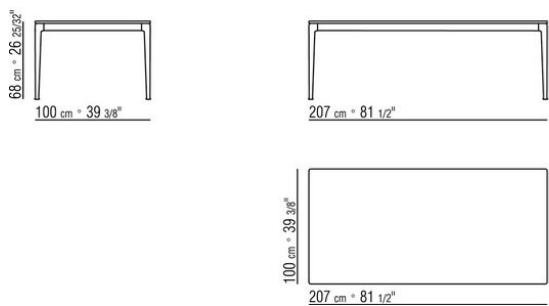

COD. 0283L2

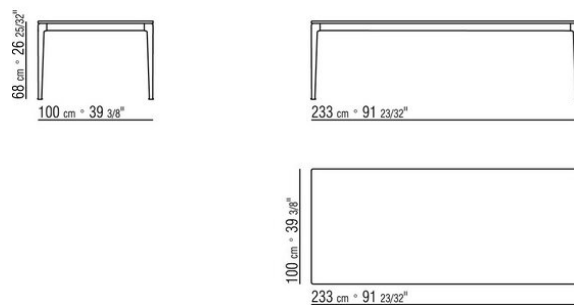

COD. 0283L4

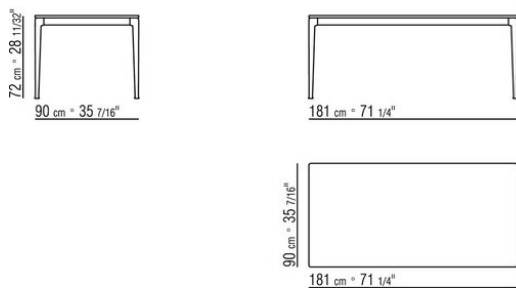

COD. 0283L5

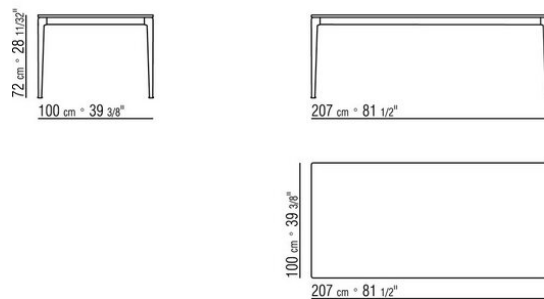

TECHNICAL DRAWINGS | PICO OUTDOOR

COD. 0283L6

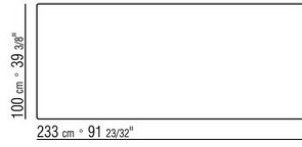
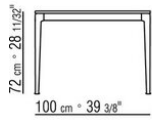

COD. 0283M0

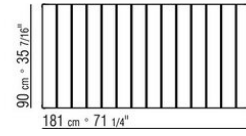
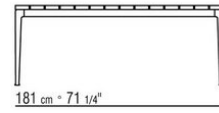
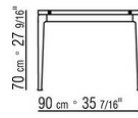

COD. 0283M1

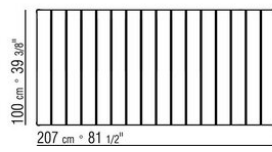
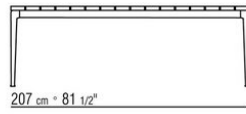
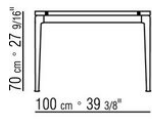

COD. 0283M2

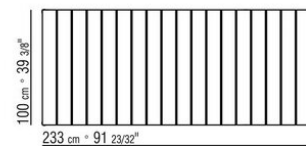
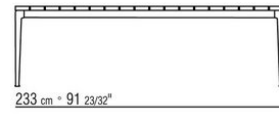
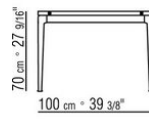

COD. 0283M4

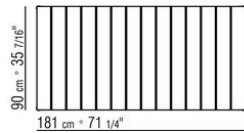
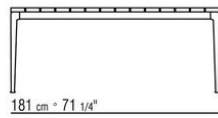
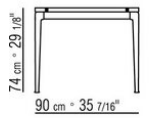

COD. 0283M5

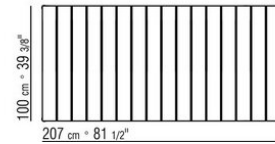
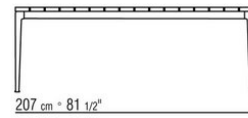
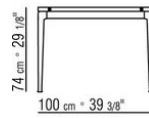

COD. 0283M6

