



**GRANDEMARE OUTDOOR ANTONIO CITTERIO 2020**  
SECTIONAL SOFAS

---

## GRANDEMARE OUTDOOR | ANTONIO CITTERIO | 2020

**Base** in 316 stainless steel with epoxy powder-coat finish and compact laminated panel. Feet rest on tips made of thermoplastic material

**Seat cushion** in polyurethane foam and polyester fiber, covered with a protective, water-repellent laminated fabric

**Upholstered backrest and armrest** in 316 stainless steel with polyurethane foam and polyester fiber, covered with a protective, water-repellent laminated fabric

**Wood armrest** in solid iroko with natural finish, stained grey, lacquered white, stained brown. Supports and screws in 316 stainless steel, spacers in die-cast zama with transparent epoxy powder-coat finish

**Wood coffee table** in solid iroko with natural finish, stained grey, lacquered white, stained brown. Supports and screws in 316 stainless steel, spacers in die-cast zama with transparent epoxy powder-coat finish

**Backrest cushion with bolster** in polyester fiber and water-repellent upholstery

**Optional cushions** in blown polyester fiber and water-repellent upholstery; upon request, with upcharge

**Upholstery** in removable fabric

**Cover** in waterproof material; cover is upon request, with upcharge

COD. 0269A2

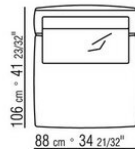
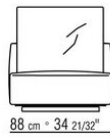
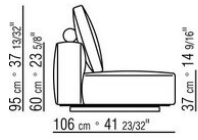

COD. 0269B1

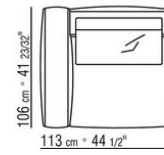
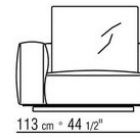
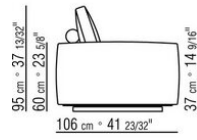

COD. 0269C1

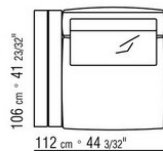
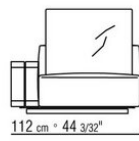
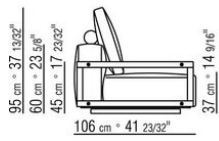

COD. 0269D1

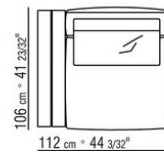
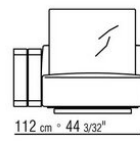
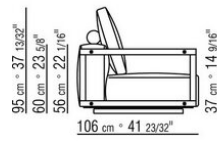

COD. 0269G0

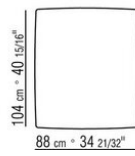
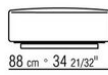
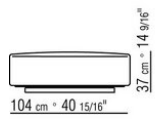

COD. 0269G2

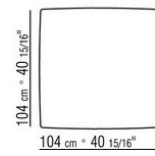
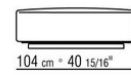
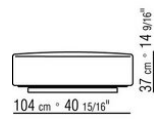

COD. 0269A3

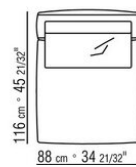
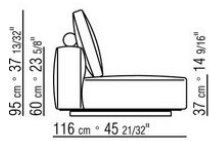

COD. 0269B3

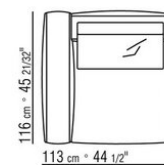
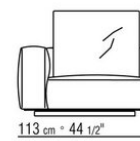
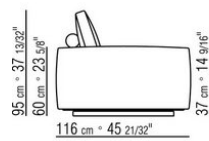

COD. 0269C3

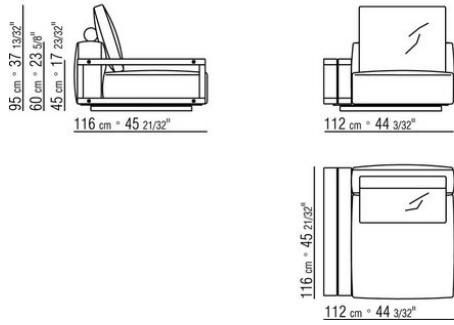

COD. 0269D3

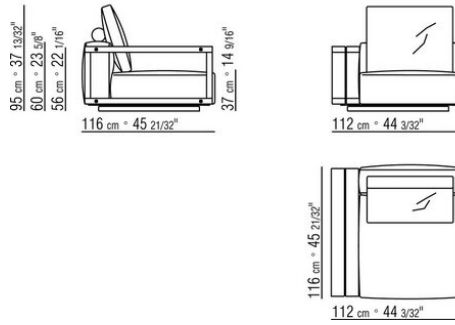

COD. 0269G1

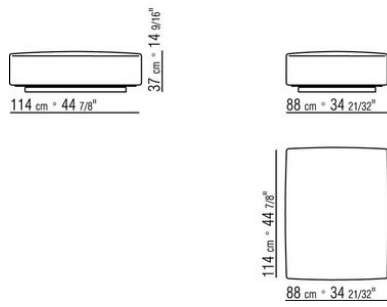

COD. 0269G3

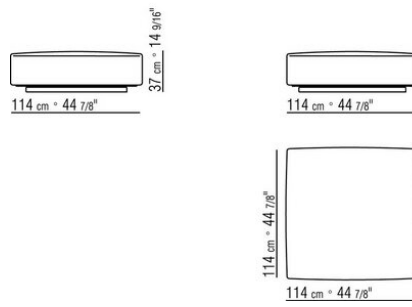

COD. 0269M7

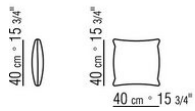

COD. 0269M8

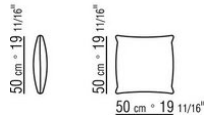

COD. 0269K0

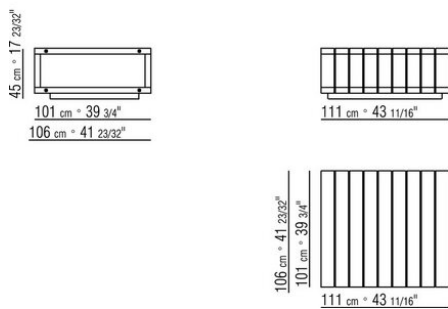

COD. 0269K1

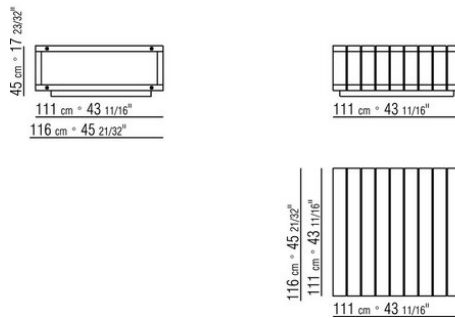

# COMPOSITIONS | GRANDEMARE OUTDOOR

---

0269XA

- N.1 COD.0269B1 - END UNIT L CM.113 x106
- N.1 COD.0269A2 - UNIT CM.88 x106
- N.1 COD.0269B0 - END UNIT R CM.113 x106

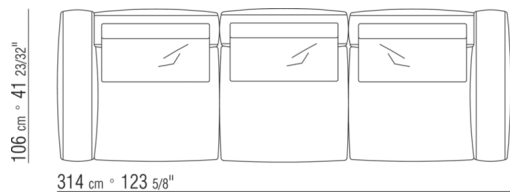

0269XB

- N.1 COD.0269B1 - END UNIT L CM.113 x106
- N.1 COD.0269A2 - UNIT CM.88 x106
- N.1 COD.0269D0 - END UNIT R W/WOODEN ARMREST CM.112 x106

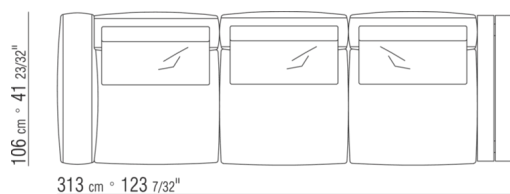

0269XE

- N.1 COD.0269D1 - END UNIT L W/WOODEN ARMREST CM.112 x106
- N.3 COD.0269A2 - UNIT CM.88 x106
- N.2 COD.0269B0 - END UNIT R CM.113 x106

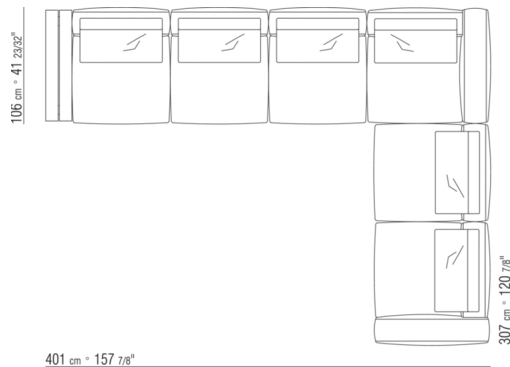

# COMPOSITIONS | GRANDEMARE OUTDOOR

0269XF

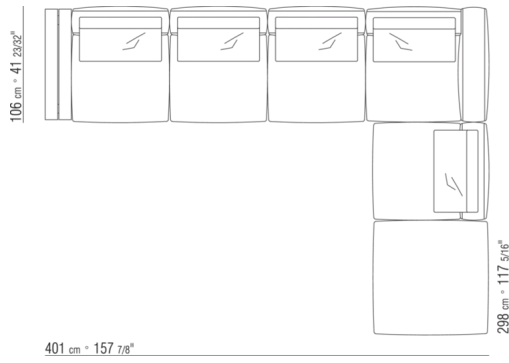

- N.1 COD.0269C1 - END UNIT L W/WOODEN LOW ARMREST CM.106 x106
- N.3 COD.0269A2 - UNIT CM.88 x106
- N.1 COD.0269B0 - END UNIT R CM.113 x106
- N.1 COD.0269G2 - OTTOMAN CM.104 x104

0269XG



- N.1 COD.0269B1 - END UNIT L CM.113 x106
- N.2 COD.0269A2 - UNIT CM.88 x106
- N.1 COD.0269K0 - SMALL TABLE CM.111 x106
- N.2 COD.0269A3 - UNIT CM.88 x116
- N.1 COD.0269G3 - OTTOMAN CM.114 x114