

Poliform

UBIK

WALK-IN CLOSETS

Poliform

UBIK WALK-IN CLOSET
DIGITAL CATALOGUE

Ubik è una cabina armadio basata sulla combinazione di boiserie e sistema a cremagliera. Evoluta e leggera, offre al contempo flessibilità e funzionalità, grazie a contenitori e accessori come vassoi, cassetti con frontale legno o cristallo, scarpiera estraibili, portapantaloni e portacamicie da posizionare all'altezza e nell'ordine desiderato. Pressoché infinite le possibilità di configurazione e di personalizzazione delle finiture.

Ubik is a walk-in closet based on the combination of wall paneling and a rack system. Advanced and light, it offers flexibility and functionality at the same time, thanks to containers and accessories such as trays, drawers with wooden or glass fronts, pull-out shoe racks, trouser racks, and shirt racks to be positioned at the height and in the order you desire. The possibilities of configuration and customization of the finishes are basically infinite.



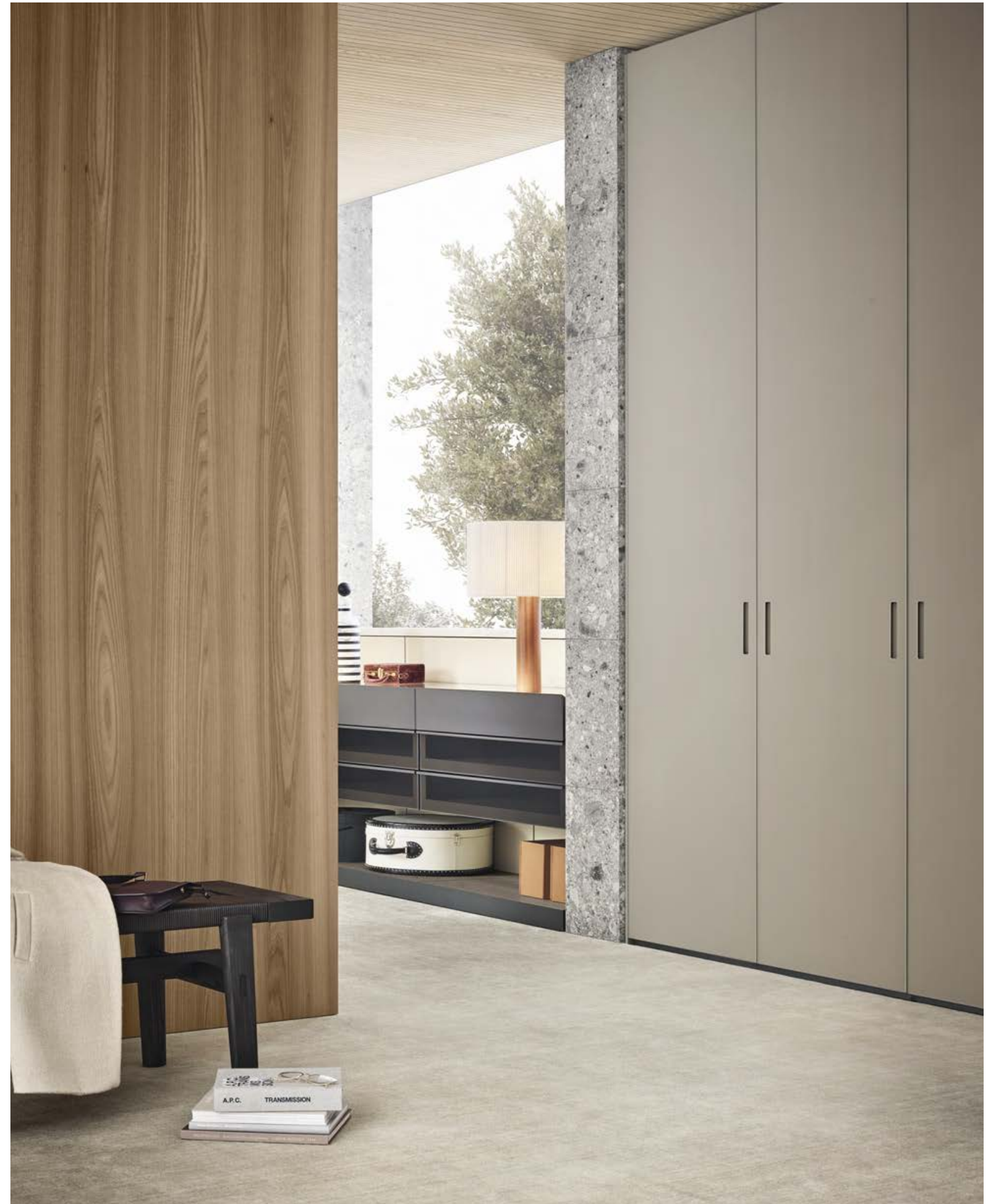



Nelle pagine precedenti e nella successiva: cabina armadio Ubik con pannelli a parete in nobilitato Skin laccato opaco 94 latte, basamenti in nobilitato rovere cenere, zoccolo in ardesia opaco. Ripiani superiori in nobilitato rovere cenere con frontale in ardesia opaco e luce led integrata. Sul ripiano più alto, scatole con coperchio rivestite in tessuto ardesia. Tubi appendiabiti rivestiti in tecnopelle 05 latte e ardesia opaco. Ripiani inferiori in tecnopelle 05 latte con telaio ardesia opaco. Armadio Senzafine Ocean con ante battenti in vetro satinato arena e telaio laccato opaco arena, maniglia Sydney a incasso laccato opaco arena. Pouf New York rivestiti in tessuto sfoderabile Skyros 02 sabbia e in pelle non sfoderabile Soft 10 prugna, entrambi con piedini brown nickel lucido. A destra: dettaglio della cassetiera a vetrina con piano superiore in vetro fumé, cassetto con frontale a smusso laccato opaco ardesia e piano in tecnopelle 05 latte, sul retro del cassetto, un soffietto chiude lo spazio dell'estrazione. Cassetti inferiori con frontali in vetro riflettente fumé con bordo e maniglia Track in ardesia opaco, piani in tecnopelle 05 latte.

Previous and next pages: Ubik walk-in closet with wall mounted panels in 94 latte mat lacquered melamine Skin, bases in cenere oak melamine, plinth in mat ardesia. Upper shelves in cenere oak melamine with front in mat ardesia and integrated led light. On the highest shelf, boxes with lid covered in fabric ardesia. Hanging bars covered in techno leather 05 latte and mat ardesia. Lower shelves in techno leather 05 latte with mar ardesia frame. Wardrobe Senzafine Ocean with leaf doors in mat glass arena and arena mat lacquered frame, Sydney built-in handle in arena mat lacquer. New York pouf covered in removable fabric Skyros 02 sabbia and in non-removable fabric Soft 10 prugna, both with glossy brown nickel feet. To the right: close up of the showcase chest of drawers with top in fumé glass, drawer with beveled front in mat lacquer ardesia and shelf in techno leather 05 latte. At the back of the drawer, a pleated fabric covers the extraction space. Lower drawers with front in fumé reflecting glass with edge and handle Track in mat ardesia, shelves in techno leather 05 latte.

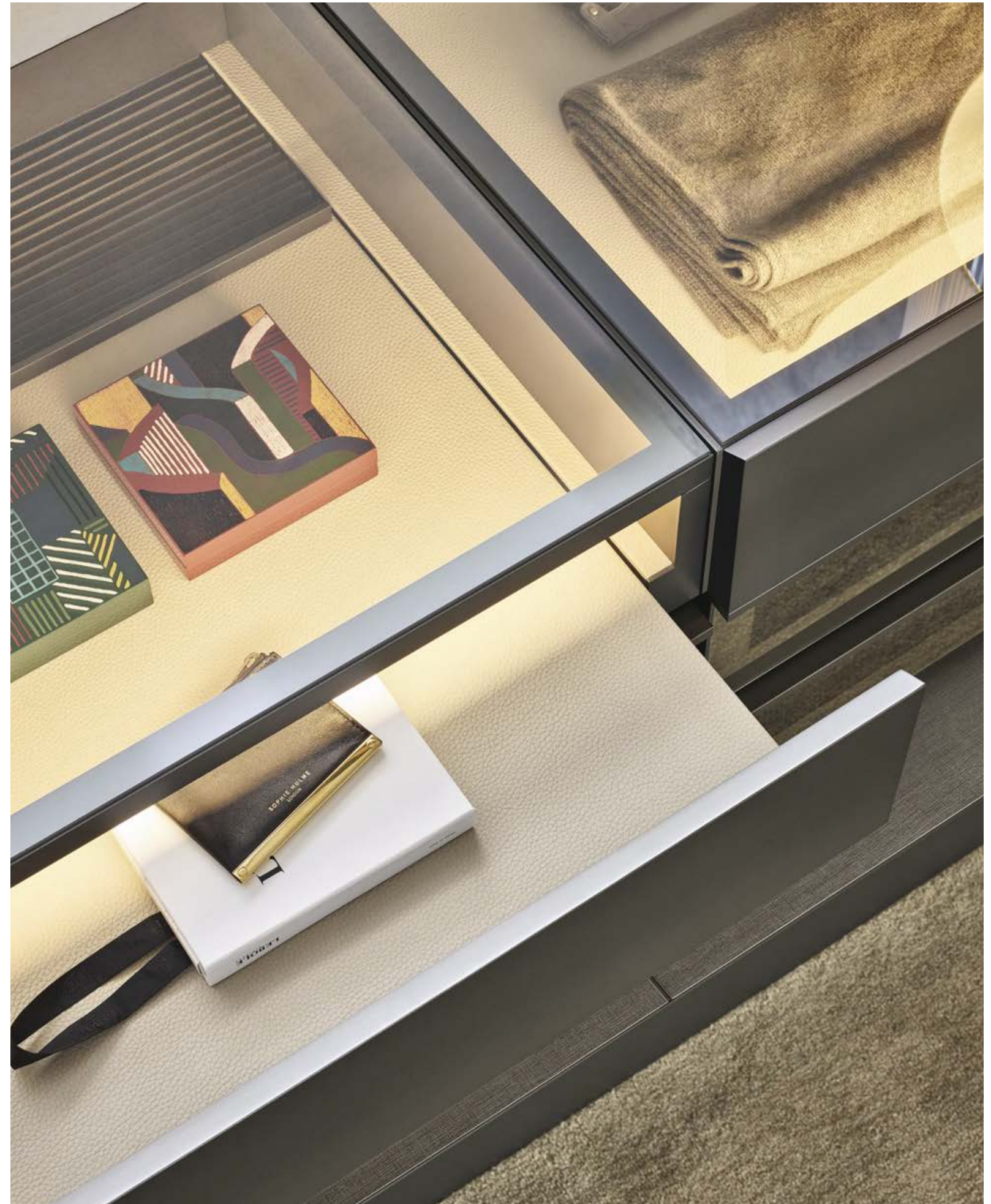





A sinistra: dettaglio del pannello a parete in nobilitato Skin laccato opaco 94 latte e del ripiano in tecnopelle 05 latte con telaio ardesia opaco. Sotto: dettaglio del tubo appendiabiti rivestito in tecnopelle 05 latte e ardesia opaco, ripiano in nobilitato rovere cenere con frontale ardesia opaco e luce led integrata.

To the left: close up of the wall mounted panel in 94 latte mat lacquered Skin melamine and of the shelf in techno leather 05 latte with mat ardesia frame. Below: close up of the hanging rail covered in techno leather 05 latte and mat ardesia, shelf in cenere oak melamine with mat ardesia front and integrated led light.

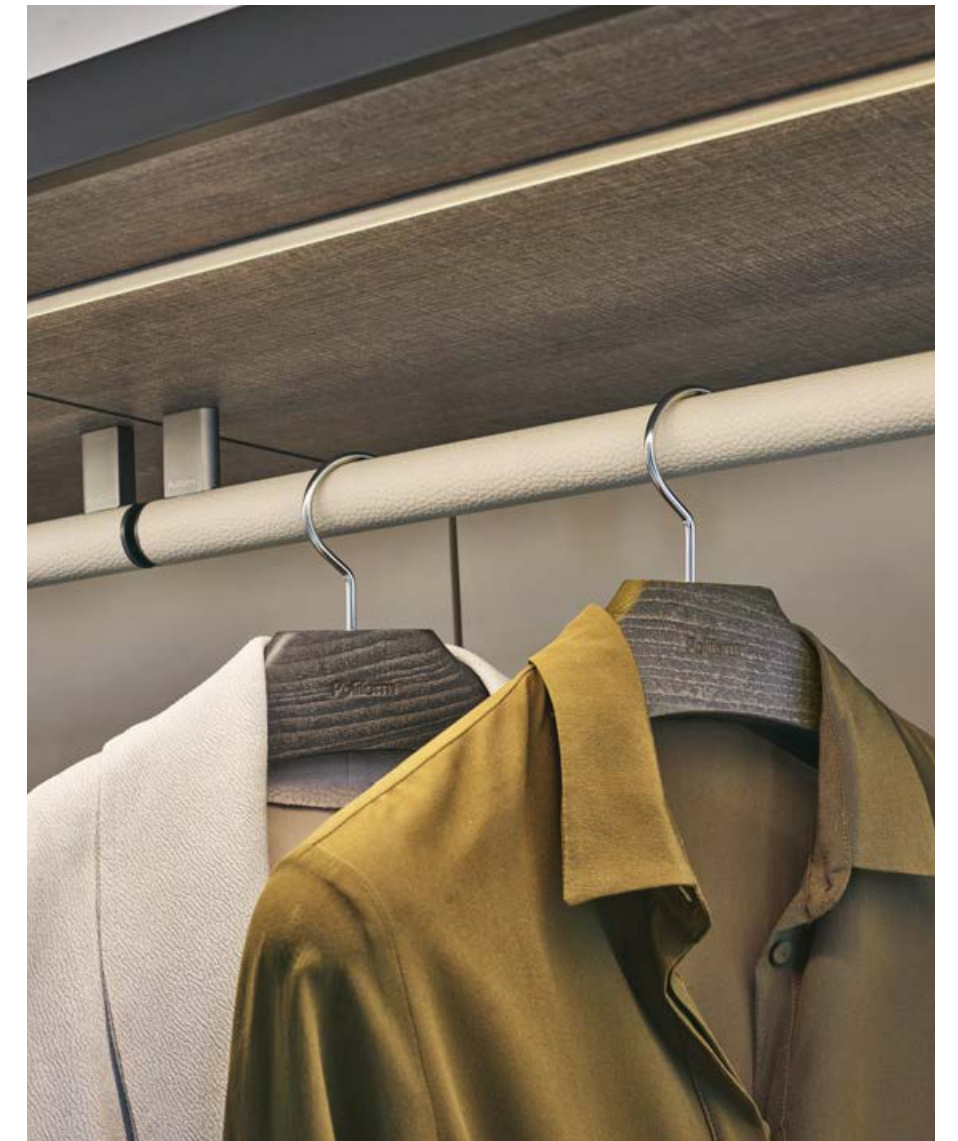

INTERIOR 16

Ubik cabina armadio

h 2590 - 990 p 605
 Pannelli a parete: nobilitato Skin laccato opaco 94 latte.
 Basamenti: nobilitato rovere cenere.
 Attrezzatura: nobilitato rovere cenere, nobilitato ardesia, vetro fumé 3050, vetro riflettente fumé 5059, tecnopelle 05 latte.
 Parti metalliche: ardesia opaco.

Senzafine Ocean

h 2590 p 609
 Apertura: battente.
 Ante: vetro satinato arena con telaio laccato opaco arena, interno laccato opaco arena.
 Maniglie: Sydney a incasso, laccato opaco arena.
 Fianchi laterali: laccato opaco arena.
 Struttura: nobilitato rovere cenere.
 Schienali: nobilitato rovere cenere.
 Attrezzatura: nobilitato rovere cenere, tecnopelle 05 latte.
 Parti metalliche: ardesia opaco.

Ubik walk-in closet

h 102" - 392 d 23 3/4"
 Wall panels: 94 latte mat lacquered Skin melamine.
 Bases: cenere oak melamine.
 Equipment: cenere oak melamine, ardesia melamine, fumé glass 3050, fumé reflecting glass 5059, techno leather 05 latte.
 Metal parts: mat ardesia.

Senzafine Ocean

h 102" d 24"
 Opening: leaf doors.
 Doors: mat glass arena with arena mat lacquered profile, mat lacquered arena rear side.
 Handles: Sydney built-in, mat lacquer arena.
 Lateral sides: mat lacquer arena.
 Structure: cenere oak melamine.
 Backs: cenere oak melamine.
 Equipment: cenere oak melamine, techno leather 05 latte.
 Metal parts: mat ardesia.

Ubik

Design R&D Poliform

Cassettiera a vetrina - Showcase chest of drawers

Design Rodolfo Dordoni

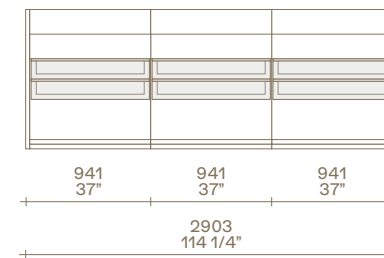
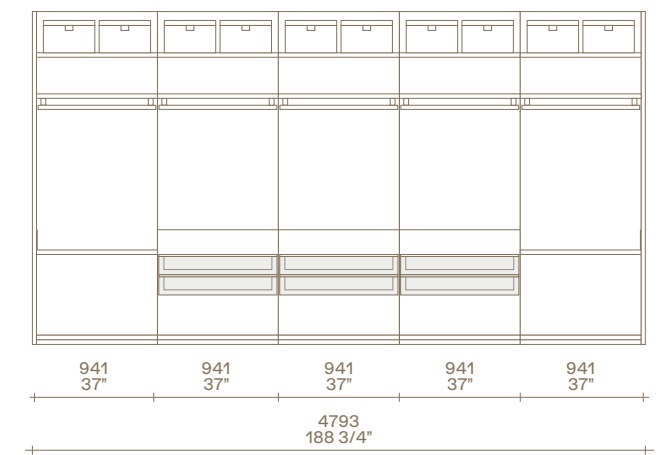
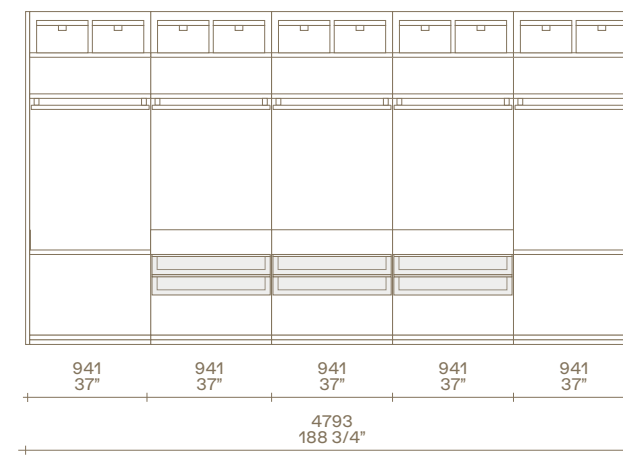

Senzafine Ocean

Design R&D Poliform

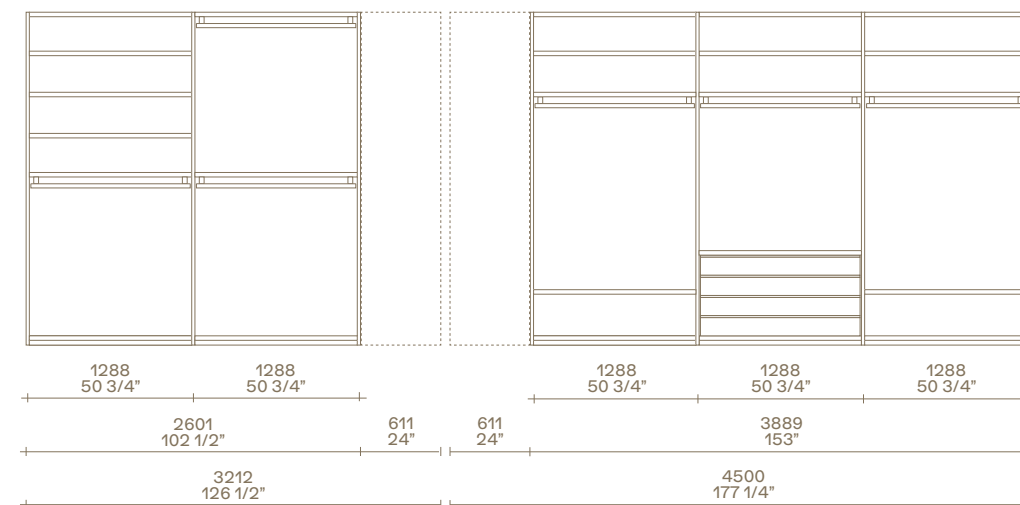







Nelle pagine precedenti: cabina armadio Ubik con pannelli a parete in nobilitato Skin laccato opaco 94 latte, basamenti in nobilitato rovere cenere, zoccolo in ardesia opaco. Ripiani in nobilitato rovere cenere e vetro fumé con telaio ardesia opaco. Cassettiere in nobilitato rovere cenere, frontali cassetti in vetro riflettente fumé con bordo e maniglia Track in ardesia opaco. In appoggio contenitori portacamicie in nobilitato rovere cenere, ripiani in tecnopelle 05 latte e cassetti rivestiti in tessuto ardesia. Armadi Senzafine Skin con ante scorrevoli coplanari in nobilitato Skin laccato opaco 94 latte. A sinistra: dettaglio dell'interno con ripiano in tecnopelle 05 latte e telaio ardesia opaco. Sotto: dettaglio della maniglia Gap in ardesia opaco e tecnopelle 05 latte.

Previous pages: Ubik walk-in closet with wall mounted panels in 94 latte mat lacquered melamine Skin, bases in cenere oak melamine, plinth in mat ardesia. Shelves in cenere oak melamine and glass fumé with mat ardesia frame. Chests of drawers in cenere oak melamine, drawer fronts in fumé reflecting glass with edge and handle Track in mat ardesia. Shirt storages in cenere oak melamine are laid on the chests of drawers, shelves in techno leather 05 latte and drawers covered in fabric ardesia. Wardrobes Senzafine Skin with coplanar sliding doors in 94 latte mat lacquered melamine Skin. To the left: close up of the interior with shelf in techno leather 05 latte and mat ardesia frame. Below: close up of the Gap handle in mat ardesia and techno leather 05 latte.







Nella pagina precedente: cabina armadio Ubik con pannelli a parete in nobilitato Skin laccato opaco 94 latte, basamenti in nobilitato rovere cenere, zoccolo in ardesia opaco. Armadi Senzafine Skin con ante scorrevoli complanari in nobilitato Skin laccato opaco 94 latte. Poltrona Mad Chair in tessuto sfoderabile Zante 10 nero e gambe in olmo nero. Panca Home Hotel in olmo nero. A sinistra: dettaglio delle cassettiere in nobilitato rovere cenere e maniglia Track in ardesia opaco, top in tecnopelle 05 latte e telaio ardesia opaco. Ripiani in vetro fumè con telaio ardesia opaco. Sotto: dettaglio del ripiano portascarpe in nobilitato rovere cenere con bordi ardesia opaco.

Previous page: Ubik walk-in closet with wall mounted panels in 94 latte mat lacquered Skin melamine, bases in cenere oak melamine, plinth in mat ardesia. Wardrobes Senzafine Skin with coplanar sliding doors in 94 latte mat lacquered Skin melamine. Mad Chair armchair in removable fabric Zante 10 nero and black elm legs. Home Hotel bench in black elm. To the left: close up of the chests of drawers in cenere oak melamine and Track handle in mat ardesia, top in techno leather 05 latte and frame in mat ardesia. Shelves in fumé glass with mat ardesia frame. Below: close up of the shoe shelf in cenere oak melamine with edges in mat ardesia.



In questa pagina: cabina armadio Ubik con pannelli a parete in nobilitato Skin laccato opaco 94 latte, basamenti in nobilitato rovere cenere, zoccolo in ardesia opaco. Ripiani in nobilitato rovere cenere e vetro fumé con telaio ardesia opaco, luce led integrata. Cassettiere in nobilitato rovere cenere e maniglia Track in ardesia opaco, piano superiore in tecnopelle 05 latte e telaio ardesia opaco. Ripiani portascarpe in nobilitato rovere cenere con bordi ardesia opaco. Armadio Senzafine Skin con ante scorrevoli complanari in nobilitato Skin laccato opaco 94 latte. Panca Home Hotel in olmo nero.

This page: Ubik walk-in closet with wall mounted panels in 94 latte mat lacquered Skin melamine, bases in cenere oak melamine, plinth in mat ardesia. Shelves in cenere oak melamine and fumé glass with mat ardesia frame, integrated led light. Chests of drawers in cenere oak melamine and Track handle in mat ardesia, upper shelf in techno leather 05 latte and mat ardesia frame. Shoe shelves in cenere oak melamine with mat ardesia edges. Wardrobe Senzafine Skin with coplanar sliding doors in 94 latte mat lacquered Skin melamine. Home hotel bench in black elm.



INTERIOR 17

Ubik cabina armadio

h 2590 p 605
 Pannelli a parete: nobilitato Skin laccato opaco 94 latte.
 Basamenti: nobilitato rovere cenere.
 Attrezzatura: nobilitato rovere cenere, vetro fumé 3050, vetro riflettente fumé 5059, tecnopelle 05 latte.
 Parti metalliche: ardesia opaco.

Senzafine Skin

h 2590 p 609
 Apertura: scorrevole complanare.
 Ante: nobilitato Skin laccato opaco 94 latte con profilo laccato opaco latte.
 Maniglie: Gap ardesia opaco, fondo tecnopelle 05 latte.
 Fianchi laterali: laccato opaco 94 latte.
 Struttura: nobilitato rovere cenere.
 Schienali: nobilitato rovere cenere.
 Attrezzatura: nobilitato rovere cenere, tecnopelle 05 latte.
 Parti metalliche: ardesia opaco.

Ubik walk-in closet

h 102" d 23 3/4"
 Wall panels: 94 latte mat lacquered Skin melamine.
 Bases: cenere oak melamine.
 Equipment: cenere oak melamine, fumé glass 3050, fumé reflecting glass 5059, techno leather 05 latte.
 Metal parts: mat ardesia.

Senzafine Skin

h 102" d 24"
 Opening: coplanar sliding doors.
 Doors: 94 latte mat lacquered Skin melamine with latte mat lacquered profile.
 Handles: Gap mat ardesia, bottom techno leather 05 latte.
 Lateral sides: mat lacquer 94 latte.
 Structure: cenere oak melamine.
 Backs: cenere oak melamine.
 Equipment: cenere oak melamine, techno leather 05 latte.
 Metal parts: mat ardesia.

Ubik Design R&D Poliform

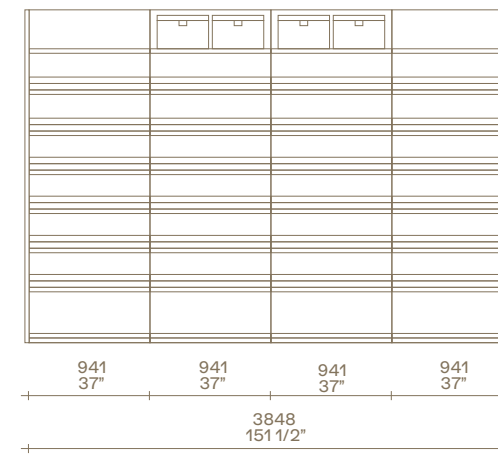
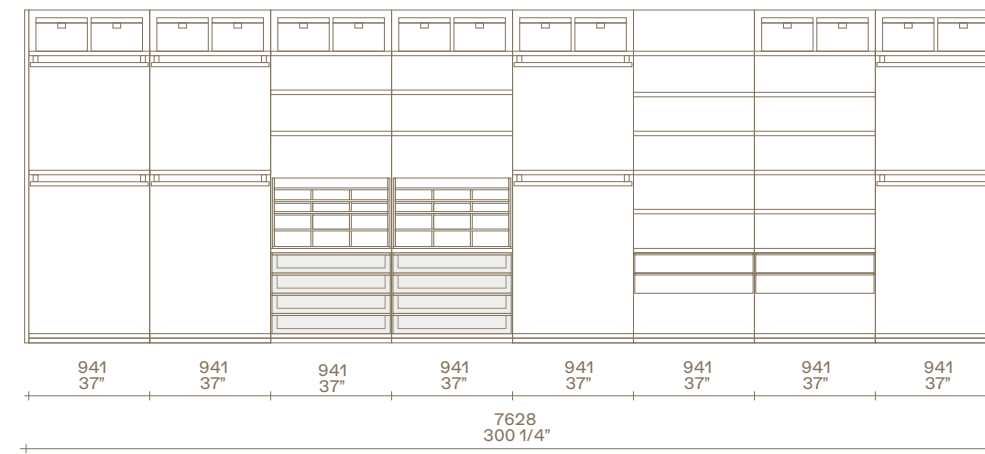

Senzafine Skin Design R&D Poliform

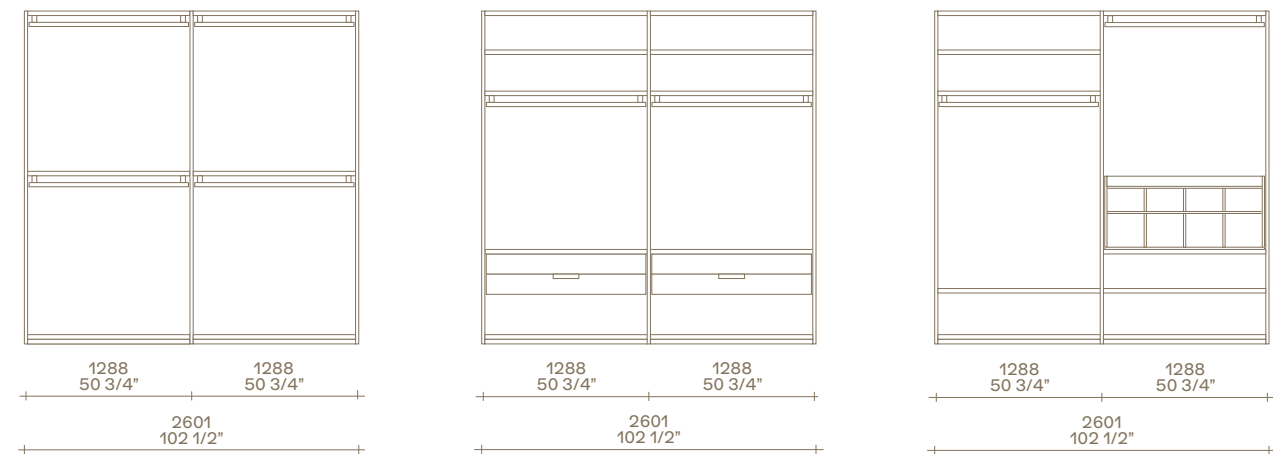

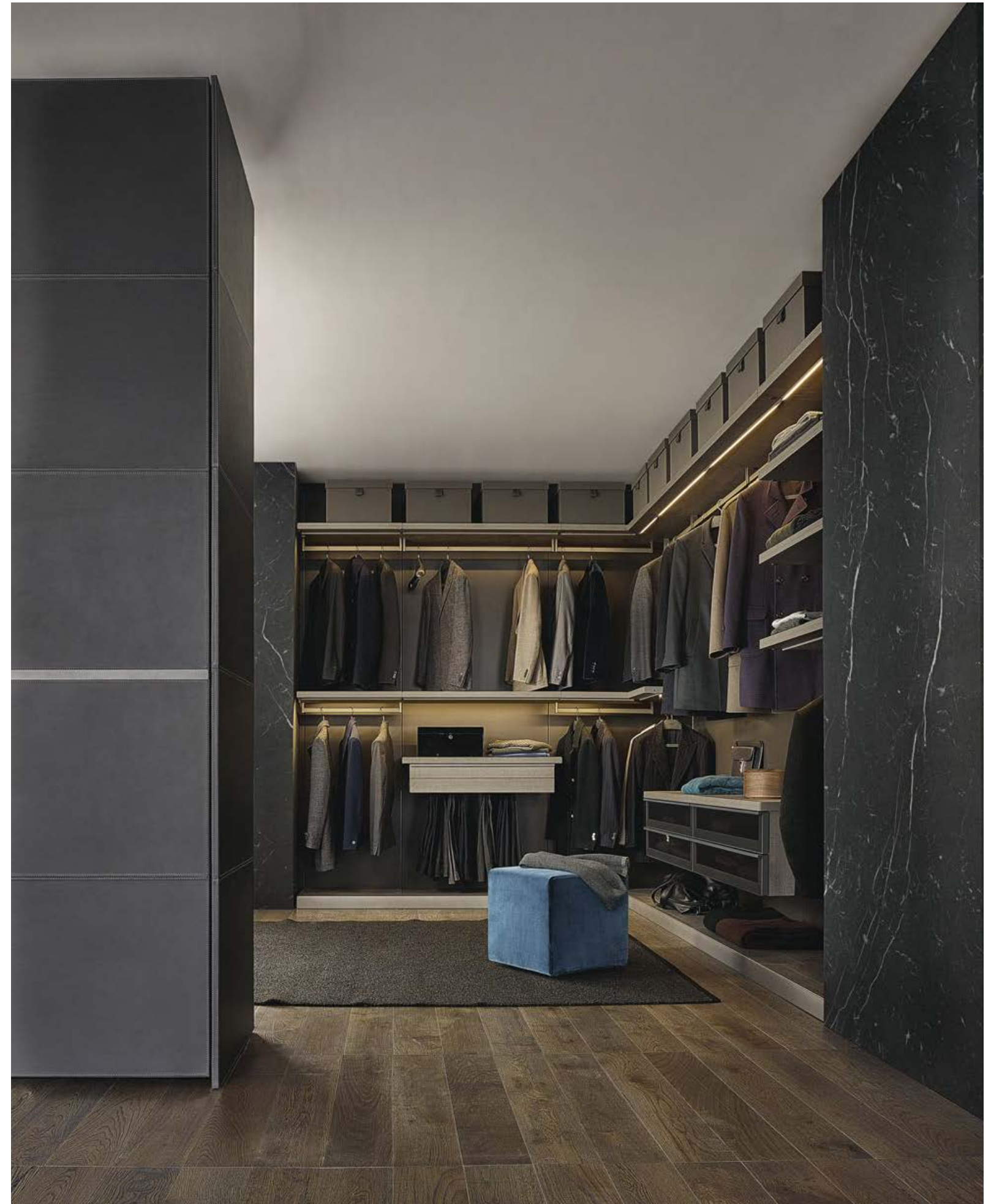





Nelle pagine precedenti: cabina armadio Ubik con pannelli a parete in vetro acidato bronzo, basamenti in nobilitato rovere cenere, zoccolo in ardesia opaco. Ripiani in nobilitato rovere cenere e luce led integrata. Pouf Play in velluto sfoderabile Persia 58 danubio. In questa pagina: dettagli delle cassettiere in nobilitato rovere cenere, frontali cassetti in vetro riflettente fumé con bordo e maniglia Track in ardesia opaco, piano superiore in nobilitato rovere cenere.

Previous pages: Ubik walk-in closet with etched glass bronzo wall panels, bases in cenere oak melamine, plinth in mat ardesia. Shelves in cenere oak melamine and integrated led light. Play pouf in removable velvet Persia 58 danubio. This page: close up of the chests of drawers in cenere oak melamine, drawer fronts in fumé reflecting glass with edge and handle Track in mat ardesia, upper shelf in cenere oak melamine.



In questa pagina: dettaglio del vassoio in nobilitato rovere cenere attrezzato con vaschette porta orologi, porta gemelli e porta orecchini rivestite in pelle grigia, maniglia Track in ardesia opaco. Porta pantaloni in nobilitato rovere cenere. Ripiani in nobilitato rovere cenere e luce led integrata.

This page: close up of the tray in cenere oak melamine accessorized with open cases, watchcase, cufflink holder and earring case covered in grey leather, Track handle in mat ardesia. Trousers hanger in cenere oak melamine. Shelves in cenere oak melamine and integrated led light.



INTERIOR 18

Ubik cabina armadio

h 2590 p 605

Pannelli a parete: vetro acidato
bronzo 5323.

Basamenti: nobilitato rovere cenere.

Attrezzatura: nobilitato rovere
cenere, vetro riflettente fumé 5059.

Parti metalliche: ardesia opaco.

Ubik walk-in closet

h 102" d 23 3/4"

Wall panels: etched glass bronzo
5323.

Bases: cenere oak melamine.

Equipment: cenere oak melamine,
fumé reflecting glass 5059.

Metal parts: mat ardesia.

Ubik

Design R&D Poliform

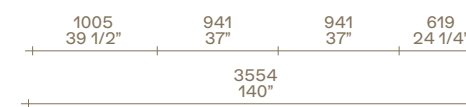
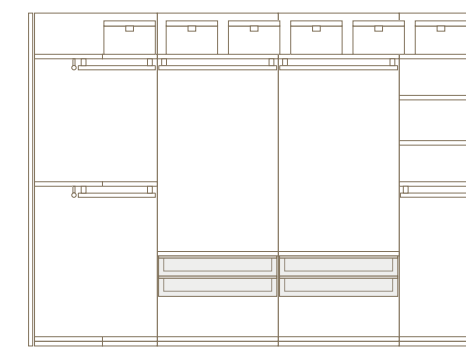
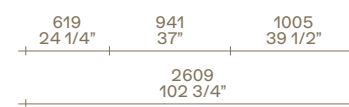
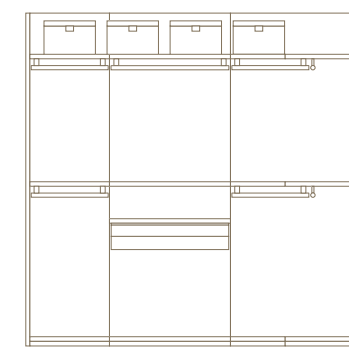

**UBIK CABINA ARMADIO
UBIKW WALK-IN CLOSET**

Ubik è un sistema di pannellature che rivestono le pareti, completate da un'ampia varietà di attrezzature. Le pannellature schienale portante sono comprensive di cremagliera per il fissaggio a muro e per il posizionamento delle attrezzature. La possibilità di posizionare le attrezzature all'altezza desiderata conferma la flessibilità del sistema.

La pannellatura schienale può essere sostituita da profili con cremagliera, fissati a muro e completati dall'attrezzatura. Il sistema inoltre prevede tagli a misura in altezza su pannellature e profili con cremagliera, tagli a misura in larghezza su pannellature, fasce di aggiustaggio, composizioni ad angolo con attrezzatura lineare e soluzioni ad angolo anche per pareti con angoli fuori squadra.

Ubik is a system of wall panelling completed by a wide variety of equipments. The self-bearing panels include the metal frame for wall fitting and for equipments positioning.

The possibility of a free positioning in height of the equipment confirms the flexibility of the system.

The wall mounted panels can be replaced by wall fitted metal profiles which can be completed by the equipments. The panels and the metal brackets can be customized in height, the panels and the filler pieces can be customized in width, the system allows corner compositions with equipment and solutions for out of square corners.

Ubik pannellatura a muro

Per ottenere la larghezza totale, aggiungere alla somma degli schienali mm 32 relativi al profilo laterale iniziale, mm 4 per ogni cremagliera e mm 32 relativi al profilo laterale terminale.

Ubik wall panelling

To obtain the total width, add up the back panel widths 1 1/4" for the initial lateral profile, 1/4" for each rack and 1 1/4" for the ending lateral profile.

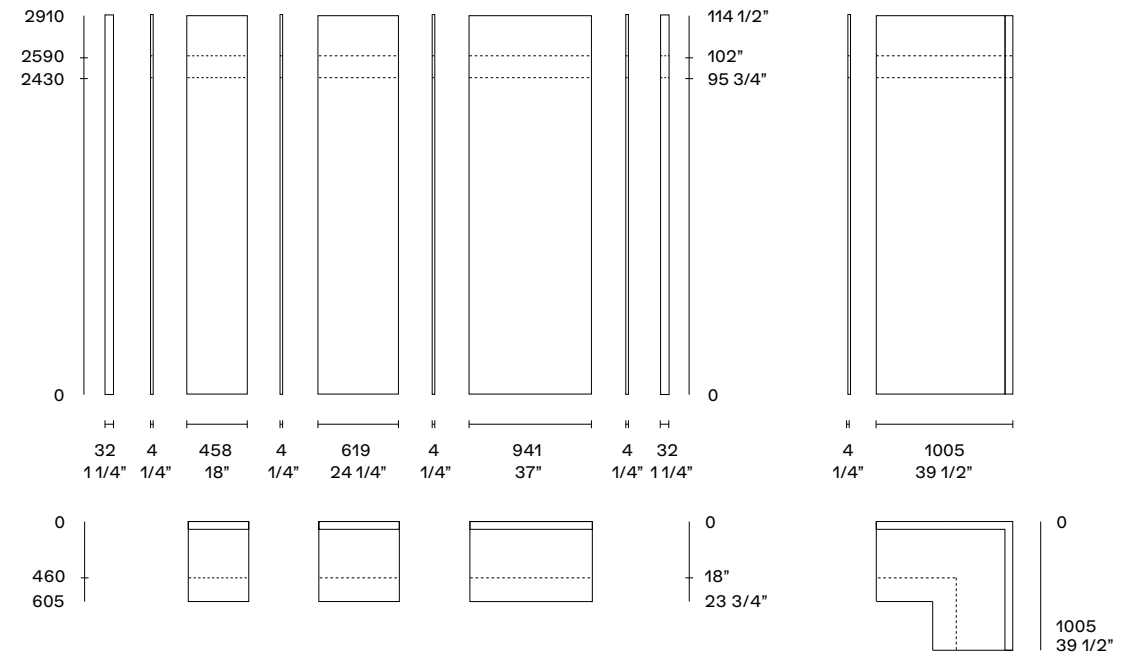

Ubik profilo con cremagliera

Per ottenere la larghezza totale, aggiungere alla somma delle larghezze dei ripiani mm 24 relativi al profilo laterale iniziale, mm 4 per ogni cremagliera e mm 24 relativi al profilo laterale terminale.

Ubik profile with rack

To obtain the total width, add up the shelves widths, 1" for the initial lateral profile, 1/4" for each rack and 1" for the ending lateral profile.

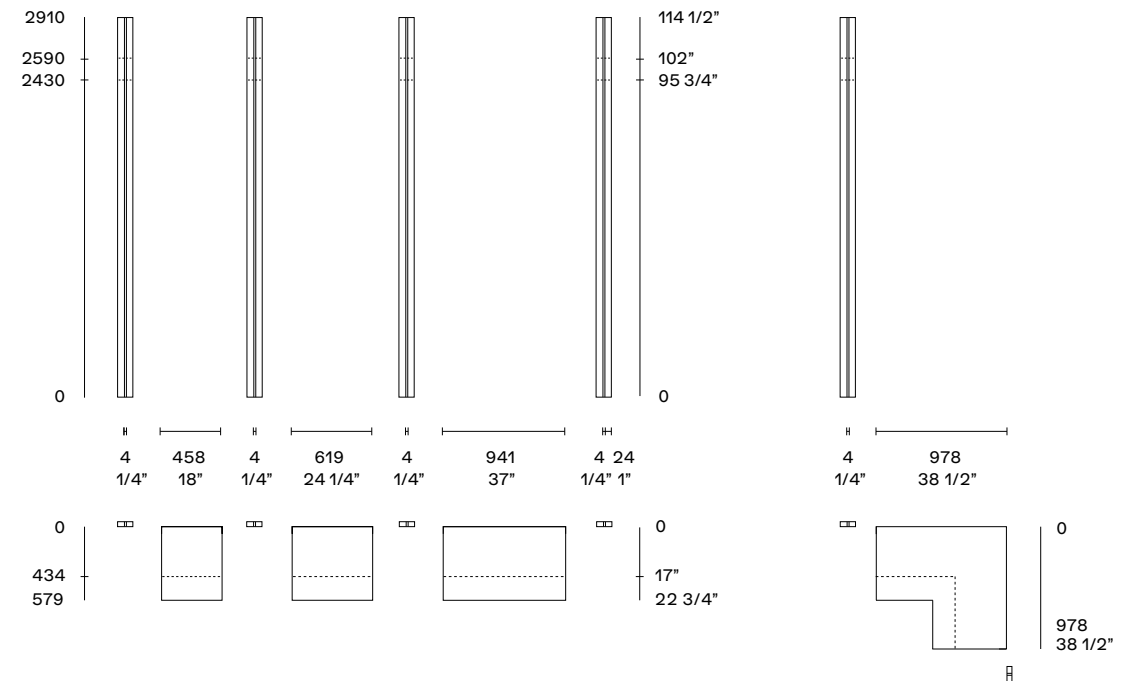

UBIK ORGANIZZAZIONE DEGLI INTERNI
UBIK INNER ORGANISATION

Attrezzature cabina armadio h 2590

- | | | |
|---|--|---|
| <p>1 1 ripiano
1 tubo appendiabiti
2 scatole larghezza mm 400
Contenitore porta scarpe con cassetti rivestiti in tessuto
Cassettiera a terra 2 cassetti legno e 1 cassetto alto legno, maniglia Track</p> <p>2 2 ripiani
2 tubi appendiabiti</p> <p>3 4 ripiani
3 scatole larghezza mm 260
3 ripiani portascarpe inclinati</p> <p>4 2 ripiani
1 tubo appendiabiti
2 scatole larghezza mm 400
Cassettiera su ruote 4 cassetti legno, maniglia Step</p> | <p>5 1 ripiano
1 tubo appendiabiti
Cassettiera a vetrina
Cassettiera sospesa 2 cassetti vetro, maniglia Track</p> <p>6 1 ripiano
1 tubo appendiabiti
Cassettiera a vetrina
Portapantaloni con vassoio portaoggetti, maniglia Track</p> <p>7 1 ripiano
1 tubo appendiabiti
1 svuotatasche
Cassettiera a terra 4 cassetti vetro, maniglia Track</p> <p>8 2 ripiani
1 servetto
Vassoio portaoggetti</p> | <p>9 2 ripiani
1 tubo appendiabiti
Portapantaloni con vassoio portaoggetti, maniglia Step</p> <p>10 2 ripiani
1 tubo appendiabiti
Contenitore portacamicie con cassetti alti e bassi rivestiti in tessuto
Cassettiera sospesa 2 cassetti legno, maniglia Track</p> <p>11 2 ripiani
1 tubo appendiabiti
Cassettiera sospesa con 2 vassoi
2 scatole larghezza mm 400</p> <p>12 4 ripiani
1 tubo appendiabiti
Contenitore portaborse</p> |
|---|--|---|

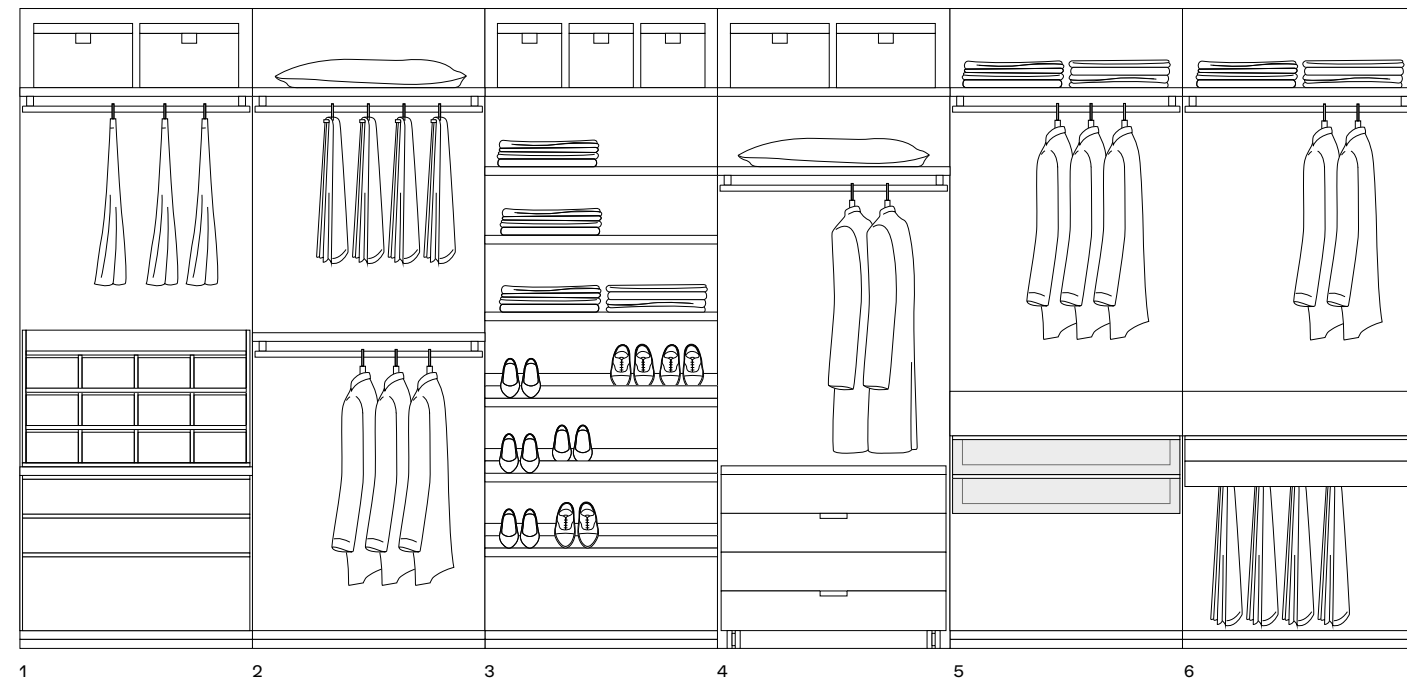

Walk-in closet equipment h 102"

- | | | |
|--|---|--|
| <p>1 2 shelves
2 hanging rails</p> <p>2 1 shelf
1 hanging rail
2 boxes width 15 3/4"
Shoes storage with drawers covered in fabric
Freestanding chest of drawers with 2 wooden drawers and 1 high wooden drawer, Track handle</p> <p>3 4 shelves
3 boxes width 10 1/4"
3 inclined shoes shelves</p> <p>4 2 shelves
1 hanging rail
2 boxes width 15 3/4"
Chest of drawers on casters 4 wooden drawers, Step handle</p> | <p>5 1 shelf
1 hanging rail
Showcase chest of drawers
Hanging chest of drawers with 2 glass drawers, Track handle</p> <p>6 1 shelf
1 hanging rail
Showcase chest of drawers
Trousers hanger with storage tray, Track handle</p> <p>7 1 shelf
1 hanging rail
1 jewellery tray
Freestanding chest of drawers with 4 glasses drawers, Track handle</p> <p>8 2 shelves
1 pull down hanging bar
Storage tray</p> | <p>9 2 shelves
1 hanging rail
Trousers hanger with storage tray, Step handle</p> <p>10 2 shelves
1 hanging rail
Shirts storage with high and low drawers covered in fabric
Hanging chest of drawers with 2 wooden drawers, Track handle</p> <p>11 2 shelves
1 hanging rail
Hanging chest of drawers with 2 trays
2 boxes width 15 3/4"</p> <p>12 4 shelves
1 hanging rail
Handbags storage</p> |
|--|---|--|

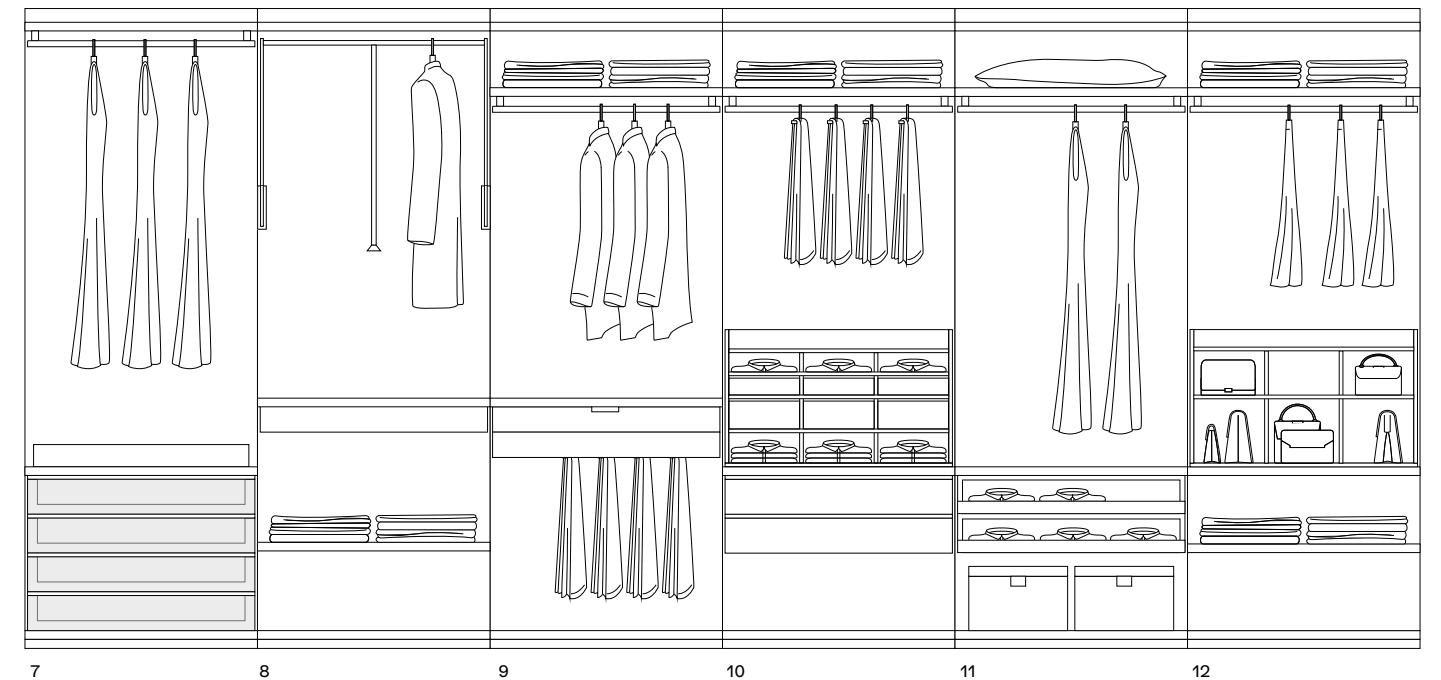

FINITURE UBIK
UBIK FINISHINGS

**Pannellatura
Panelling**



olmo - elm
nobilitato - melamine



noce c. - walnut c.
nobilitato - melamine



rovere cenere
cenere oak
nobilitato - melamine



rovere spessart
spessart oak
nobilitato - melamine



canvas beige
nobilitato - melamine



canvas grigio
nobilitato - melamine



ardesia
nobilitato - melamine



roller latte
metacrilato
methacrylate



roller ardesia
metacrilato
methacrylate



skin
nobilitato - melamine
27 colori laccato opaco
27 mat lacquered colours



skin 94 latte
nobilitato - melamine
laccato opaco
mat lacquered

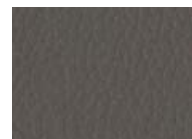

skin 97 elefante
nobilitato - melamine
laccato opaco
mat lacquered



skin 93 moro
nobilitato - melamine
laccato opaco
mat lacquered



skin 98 nocciola
nobilitato - melamine
laccato opaco
mat lacquered

**Pannellatura vetro
Glass panelling**

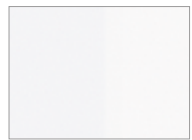

2201 bianco extralight
vetro lucido
glossy glass



2273 ghiaccio
vetro lucido
glossy glass



1235 canapa
vetro lucido
glossy glass



1264 arena
vetro lucido
glossy glass



1204 grafite
vetro lucido
glossy glass



1203 nero
vetro lucido
glossy glass

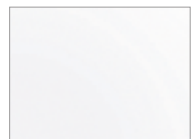

4000 specchio bianco
white mirror



5380 acciaio
vetro acidato
etched glass



5323 bronzo
vetro acidato
etched glass



5325 titanio
vetro acidato
etched glass

**Profili con cremagliera
Profile with rack**

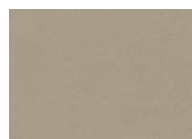

champagne opaco
mat champagne



ardesia opaco
mat ardesia

**Attrezzatura
Equipment**



olmo - elm
nobilitato - melamine



noce c. - walnut c.
nobilitato - melamine



rovere cenere
cenere oak
nobilitato - melamine



rovere spessart
spessart oak
nobilitato - melamine



canvas beige
nobilitato - melamine



canvas grigio
nobilitato - melamine



ardesia
nobilitato - melamine

**Ripiani tecnopelle
Techno leather shelves**



05 latte
tecnopelle
technoleather

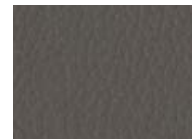

01 elefante
tecnopelle
technoleather



02 moro
tecnopelle
technoleather



06 nocciola
tecnopelle
technoleather

**Ripiani vetro
Glass shelves**



3050 fumé

**Frontale cassetti
Drawers front**



olmo - elm
nobilitato - melamine



noce c. - walnut c.
nobilitato - melamine



rovere cenere
cenere oak
nobilitato - melamine



rovere spessart
spessart oak
nobilitato - melamine

* Finitura roller anche per frontali
vassoi portaoggetti e portapan-
taloni degli elementi sospesi.
Finish roller also for trays and
trousers hangers fronts of the
hanging units.



canvas beige
nobilitato - melamine



canvas grigio
nobilitato - melamine

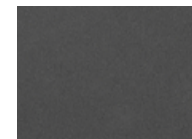

ardesia
nobilitato - melamine



roller latte
metacrilato
methacrylate *



roller ardesia
metacrilato
methacrylate *

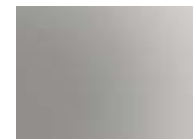

5059
vetro riflettente fumé
fumé reflecting glass

**Interno cassetti
Drawers interior**



ardesia
nobilitato - melamine

**Parti metalliche, ferramenta
Metal parts, hardware**

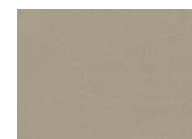

champagne opaco
mat champagne



ardesia opaco
mat ardesia

Poliform Spa

via Montesanto 28
Casella postale n. 1
22044 Inverigo (CO) Italy
t +39 031 6951
f +39 031 699444
info@poliform.it
poliform.it

Poliform realizza tutte le sue collezioni in Italia usando componenti e materie prime selezionate.

All the Poliform collections are manufactured 100% in Italy using top-class components and materials.

Poliform si riserva il diritto di apportare, senza preavviso, ogni modifica mirata al miglioramento funzionale e qualitativo dei propri prodotti. Testi e disegni presenti in questo stampato hanno scopo divulgativo; per ogni aspetto tecnico e dimensionale fare riferimento ai listini aziendali e relativi aggiornamenti. I campioni di colori e materiali hanno valore indicativo.

Poliform reserves the rights at all time to apply modifications for the functional or qualitative improvement of its products. Texts and drawings present in this brochure have a divulgative purpose; for every technical and dimensional aspect please refer to the company's price lists and their relative updatings. The colour and material samples have an indicative value.



2018 Adi Compasso D'oro
Career Award